



www.QUALITERRA.de

 **EUROPA:**

QualiTerra GmbH
Alexandrinenstr. 13
96450 Coburg
GERMANY

Telefon +49 9561 799 43 - 0
info@qualiterra.de



 **FRANKREICH:**

Bureau de représentation France:
Tél: +33 (0) 6 11 33 00 14
amjfort@gmail.com

 **United KINGDOM:**

Fon +44 787 40 10 218
steven.lui@qualiterra.de



OUTDOOR-CATALOG
2024/2025



www.Qualiterra.de



Liebe spielbegeisterte Abenteurer,

wir sind QualiTerra, ein junges Unternehmen aus Coburg, welches sich auf die Ausstattung und Einrichtung von Spielorten für Kinder spezialisiert hat. Unser Team ist seit vielen Jahren in der Branche tief verwurzelt, daher wissen wir was es braucht, um hochwertige Lösungen anzubieten.

Unser Sortiment an Außenspielgeräten und Kindergartenmöbeln überzeugt durch innovatives Design, das individuell kombinierbar und gestaltbar ist. Die Verbindung aus rostfreien Aluminium-Pfosten und hochwertigen HPL-Interaktionswänden garantiert nicht nur nachhaltigen Spielspaß, sondern auch eine lange Lebensdauer – und das bei minimalem Wartungsaufwand. So schaffen wir sichere und fantasievolle Spielwelten für die nächste Generation.

Viel Spaß beim Entdecken!

Ihr QualiTerra Team

Dear play-loving adventurers,

We are QualiTerra, a young company from Coburg that specializes in equipping and furnishing play areas for children. Our team has been deeply rooted in the industry for years, so we know what it takes to offer the highest quality solutions.

Our range of outdoor play equipment and nursery furniture impresses with its innovative design, which can be individually combined and customized. The combination of rust-free aluminum posts and high-quality HPL interaction walls guarantees not only sustainable play fun, but also a long service life - with minimal maintenance. This is how we create safe and imaginative play worlds for the next generation.

Have fun discovering!

Your QualiTerra Team

Chers aventuriers passionnés de jeux,

Nous sommes QualiTerra, une entreprise dynamique basée à Cobourg, spécialisée dans l'équipement et l'aménagement des aires de jeux pour enfants. Notre équipe, forte de nombreuses années d'expérience dans le secteur, possède une connaissance approfondie des besoins et des exigences, ce qui nous permet de proposer des solutions de la plus haute qualité.

Notre gamme d'équipements de jeux d'extérieur et de mobilier pour la petite enfance se distingue par son design innovant, modulable et personnalisable selon les besoins. L'alliance de poteaux en aluminium inoxydable et de panneaux d'interaction en HPL de haute qualité garantit non seulement un plaisir de jeu durable, mais aussi une longévité exceptionnelle, le tout avec une facilité de montage et un minimum d'entretien. Ainsi, nous créons des univers de jeu sûrs, plus imaginatifs, inclusifs, pour les générations futures.

Nous vous souhaitons beaucoup de plaisir à les découvrir !

Votre équipe QualiTerra

INHALT

TABLE OF CONTENTS | TABLE DES MATIÈRES

• Unternehmen Company Profile Entreprise	02-05
• Qualität Quality promise Promesse de qualité	06-07
• Eco Wooden Qualität ECO-Wooden Quality Gamme Eco Wood	08-11
• Rutschen & Funktionswände Slides & Game Panels Toboggans & Parois fonctionnelles	12-13
• Erlebniswelten Experience Worlds Mondes d'expérience	14-19
• Spieltürme Play Towers Tour de jeux	20-71
• Seilspielanlagen Rope Net Systems Structure de corde à grimper	72-73
• Drehkarussells Carousels	74-75
• Wippen Rockers Gamme à bascule	76-77
• Schaukeln Swings Gamme Swing	78-79
• Musikspiel Serie Music Play Series Gamme musicale	80-81
• Sand & Wasserspiel Sand & Water Play Gamme eau et sable	82-83
• Kleinspielgeräte Mini-Rider Series Gamme Mini-Rider	84-85



QualiTerra GmbH

Alexandrinenstr. 13 | 96450 Coburg | GERMANY

Telefon +49 9561 799 43 - 0
info@qualiterra.de



www.Qualiterra.de



Terra
langlebig & nachhaltig

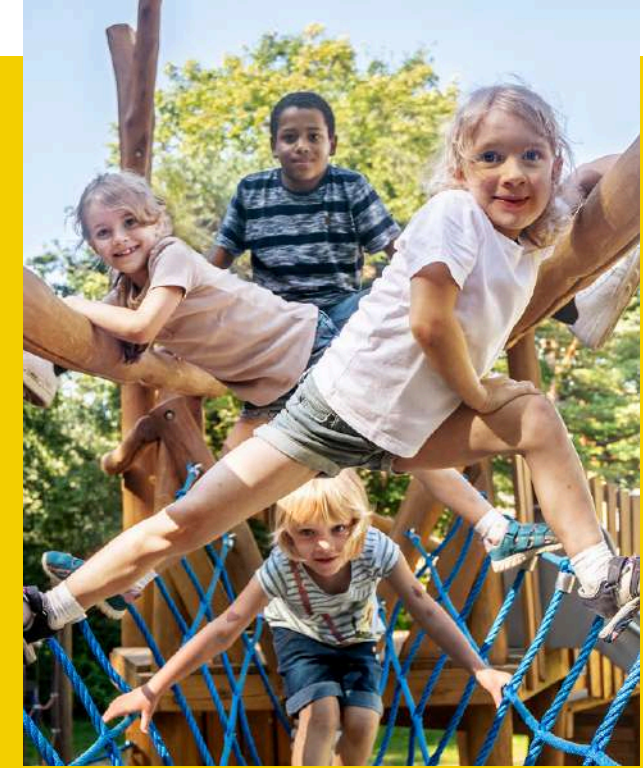

Qualität
hochwertig & robust

Erstklassige QUALITÄT und innovatives DESIGN für Spielplatz und Kindergarten.

First-class QUALITY and innovative DESIGN for playgrounds and kindergartens.

Une QUALITE de première classe et un DESIGN innovant pour les aires de jeux et les jardins d'enfants



Design
innovativ & individuell

UNTERNEHMEN

COMPANY PROFILE

ENTREPRISE



Über uns

Seit 2023 steht QualiTerra für hochwertige Spielplätze und Kindertageeinrichtungen – innen und außen. Unsere Produkte vereinen Qualität, Sicherheit und Flexibilität und sind sowohl für den Innen- als auch für den Außenbereich konzipiert. Für unsere Außenspielgeräte setzen wir auf robuste Aluminiumpfosten und langlebige HPL-Platten, die höchste Widerstandsfähigkeit und Langlebigkeit garantieren.

Warum Spielplätze wichtig sind

Wir wissen, wie wichtig es ist, Kindern Räume zu bieten, in denen sie ihre Umgebung erkunden, ausprobieren und auch mal hinfallen können – und dabei lernen, wieder aufzustehen. Denn genau das ist der Kern einer guten Entwicklung: zu wachsen, sich selbst zu überwinden und immer wieder neue Herausforderungen zu meistern. Unsere Spielplätze und Möbel bieten genau diese Möglichkeiten – sichere und kreative Umgebungen, die Kindern helfen, wichtige soziale und motorische Fähigkeiten zu entwickeln.

Unser Engagement

Mit unserer hohen Fertigungstiefe können wir flexibel auf die individuellen Wünsche unserer Kunden eingehen und maßgeschneiderte Lösungen entwickeln. Ob Innen- oder Außeneinrichtungen – jedes unserer Produkte wird von einem erfahrenen Team entwickelt, das sein Fachwissen und seine jahrelange Erfahrung einbringt. Unser Ziel ist es, Möbel und Spielgeräte zu schaffen, die Kinder inspirieren und ihnen helfen, ihre eigenen Grenzen zu entdecken.

Bei QualiTerra stehen wir für innovative Ideen und zukunftsweisende Lösungen, die die Bedürfnisse der Kinder von heute erfüllen und eine bessere, nachhaltigere Zukunft unterstützen.

About us

Since 2023, QualiTerra has stood for high-quality playgrounds and kindergarten facilities - indoors and outdoors. Our products combine quality, safety and flexibility and are designed for both indoor and outdoor use. For our outdoor play equipment, we rely on robust aluminum posts and durable HPL panels that guarantee maximum resistance and longevity.

Why playgrounds are important

We know how important it is to offer children spaces where they can explore their surroundings, try things out and even fall down - and learn to get up again in the process. After all, this is the core of good development: to grow, to overcome oneself and to master new challenges again and again. Our playgrounds and furniture offer exactly these opportunities - safe and creative environments that help children to develop important social and motor skills.

Our commitment

With our high level of vertical production integration, we can respond flexibly to the individual wishes of our customers and develop customized solutions. Whether indoor or outdoor furniture - each of our products is developed by an experienced team who contribute their expertise and years of experience. Our aim is to create both indoor and outdoor furniture and play equipment that inspire children and help them discover their own limits.

At QualiTerra, we stand for innovative ideas and forward-thinking solutions that meet the needs of today's children and support a better, more sustainable future.

À propos de nous

Depuis 2023, QualiTerra se distingue par la conception et la fabrication d'aires de jeux ainsi que d'équipements pour les structures d'accueil en crèches, scolaires et périscolaires, tant à l'intérieur qu'à l'extérieur. Nos produits allient qualité, sécurité et flexibilité et sont adaptés pour une utilisation en intérieur comme en extérieur. Pour nos équipements d'extérieur, nous privilégions des poteaux en aluminium robustes et des panneaux en HPL durables, assurant une résistance et une longévité maximales.

L'importance des aires de jeux

Nous comprenons l'importance cruciale de fournir aux enfants des espaces où ils peuvent explorer, expérimenter et s'amuser librement. C'est au cœur de leur développement : grandir, se dépasser et relever continuellement de nouveaux défis. Nos aires de jeux et notre mobilier créent précisément ces opportunités – des environnements sûrs et stimulants qui aident les enfants à développer des compétences sociales et motrices essentielles.

Notre engagement

Grâce à notre grande capacité de production, nous répondons avec souplesse aux demandes spécifiques de nos clients, en les accompagnant dans le développement d'une solution adaptée. Que ce soit pour l'aménagement intérieur ou extérieur, chacun de nos produits est conçu par une équipe expérimentée, forte de nombreuses années de savoir-faire. Notre mission est de créer des meubles et des équipements de jeu qui inspirent les enfants et les encouragent à repousser leurs propres limites tout en vous apportant la garantie d'un projet réussi.

Chez QualiTerra, nous incarnons des idées innovantes et des solutions tournées vers l'avenir, répondant aux besoins des enfants d'aujourd'hui tout en contribuant à un futur meilleur et plus durable.

steht für QUALITÄT

QualiTerra steht für erstklassige QUALITÄT einer einzigartigen Produktvielfalt in innovativem DESIGN.

Jedes QualiTerra-Produkt wird mit hochwertigen Materialien hergestellt, um Langlebigkeit, Sicherheit und Funktionalität zu gewährleisten. Unsere Spielgeräte erfüllen die DIN EN 1176.

Im Außenspielbereich setzen wir besonders auf Aluminium, da es ein nachhaltiges Material für Spielgeräte im Freien ist. Es ist außerordentlich wetterbeständig, was bedeutet, dass es gegen Rost und Korrosion, durch Regen oder Feuchtigkeit resistent ist - ein wichtiger Faktor für die Langlebigkeit der Spielgeräte. Zudem ist Aluminium leicht und dennoch stabil, was die Installation sicher und einfach macht und gleichzeitig robust genug für das energische Spiel von Kindern ist.

Qualitätsgarantie

Alle unsere Produkte sind vor Auslieferung entsprechend den EU-Anforderungen zertifiziert. QualiTerra gibt auf alle Produkte der Eigenmarke grundsätzlich 10 Jahre Garantie. Unser Ziel ist es, Produkte so langlebig zu entwickeln, dass Sie diese Garantie nicht in Anspruch nehmen müssen - doch "sicher ist sicher".

Full Service

Sie erhalten von uns umfassende Beratung und vor Auftragserteilung eine 3D Zeichnung der Spielgeräte auf Ihrer Fläche. Wir liefern nach ganz Europa per Spedition. In Deutschland übernehmen wir auf Wunsch und gegen Aufpreis auch den Aufbau. Nach Montage unterstützen wir die verpflichtende Abnahme durch eine zertifizierte Spielplatzprüfstelle. Sprechen Sie uns an für inklusive Spielplätze oder die Möglichkeit eines integrierten Sonnenschutzes.

After Sales Service

Nach der Lieferung bieten wir umfassende Unterstützung an, einschließlich einer detaillierten Installationsanleitung oder Installation durch unsere Servicepartner. Auch nach der Fertigstellung stehen wir Ihnen gerne für Fragen zur Verfügung.

Unser Qualitätsversprechen!

- ✓ Pfosten aus Aluminium
- ✓ hochwertiges HPL in vielen Farben
- ✓ wetterbeständig & langlebig
- ✓ pflegeleicht & spreißelfrei
- ✓ individuell kombinierbar & gestaltbar
- ✓ Sonnenschutz möglich
- ✓ TÜV geprüft - DIN EN 1176
- ✓ 10 Jahre Garantie



QualiTerra stands for first-class QUALITY of a unique product variety in innovative DESIGN.

Every QualiTerra product is manufactured using high-quality materials to ensure durability, safety and functionality. Our play equipment complies with DIN EN 1176.

In the outdoor play area, we particularly rely on aluminum as it is a sustainable material for outdoor play equipment. It is exceptionally weather resistant, which means that it is resistant to rust and corrosion from rain or moisture - an important factor for the longevity of the play equipment. In addition, aluminum is lightweight yet strong, making it safe and easy to install while being robust enough for children's energetic play.

Full service

You will receive extensive support from us and a 3D drawing of the play equipment on your site before placing the order. We deliver throughout Europe by forwarding agent. Contact us for inclusive playgrounds or the option of integrated sun protection.

QualiTerra est synonyme de QUALITÉ de premier ordre et d'une diversité unique de produits au DESIGN innovant.

Chaque produit QualiTerra est fabriqué avec des matériaux de haute qualité afin de garantir sa longévité, sa sécurité et sa fonctionnalité. Nos équipements de jeux sont conformes à la norme DIN EN 1176.

Dans le domaine des jeux d'extérieur, nous misons particulièrement sur l'aluminium, car c'est un matériau durable pour les équipements de jeu en plein air. Il est extrêmement résistant aux intempéries, ce qui signifie qu'il résiste à la rouille et à la corrosion causée par la pluie ou l'humidité - un facteur important pour la longévité des équipements de jeu. De plus, l'aluminium est léger mais solide, ce qui rend l'installation sûre et facile, tout en étant suffisamment robuste pour les jeux énergiques des enfants.

Service complet

Vous recevrez une assistance complète de notre part et un dessin en 3D de l'équipement de jeu sur votre site avant de passer la commande. Nous livrons dans toute l'Europe par transporteur. Contactez-nous pour les aires de jeux inclusives ou l'option de protection solaire intégrée.

Our quality promise | Notre promesse de qualité

- ✓ Posts made of aluminum | poteaux en aluminium
- ✓ High-quality HPL in many colors | HPL de haute qualité dans de nombreux coloris
- ✓ weather-resistant & durable | Résistant aux intempéries & durable
- ✓ easy-care & splinter-free | facile à entretenir & ne se fissure pas
- ✓ individually combinable & customizable | combinable & personnalisable
- ✓ Sun protection possible | Protection solaire possible
- ✓ TÜV tested - DIN EN 1176 | testé par le TÜV - DIN EN 1176
- ✓ 10 year guarantee | 10 ans de garantie



ECO-WOODEN QUALITY

Die **Eco-wood-Serie** stellt eine natürliche Umgebung dar. Die Kinder interagieren auf ihre eigene Art und Weise mit der sie umgebenden Umwelt, was eine schrittweise Einführung in die Erfahrung und das Verständnis der realen Welt ermöglicht.

Eco-wood series is designed to simulate natural ecology. Children interact with the surrounding environment in their own unique way, so they can gradually accumulate experience in playing, and form a knowledge and understanding of the world.

La **série Eco-wood** est conçue pour imiter les matériaux naturels. Les enfants interagissent avec l'environnement à leur manière, permettant une introduction progressive aux expériences et à la compréhension du monde réel.

SYSTEM-KOMPONENTE SYSTEM COMPONENT | COMPOSANT DU SYSTÈME

Die **QualiTerra Eco Serie** bietet modulare Komponenten für vielseitige Spielmöglichkeiten. Sie besteht aus langlebigen HPL-Platten und umfasst interaktive Spielelemente, Fenster und Türen. Diese lassen sich nahtlos mit verschiedenen Rutschen und stabilen Stützrahmen verbinden. Hochwertige Verbindungs- und Befestigungselemente sorgen für Stabilität und Sicherheit und machen die Eco-Serie zu einer sehr flexiblen Spielplatzlösung.







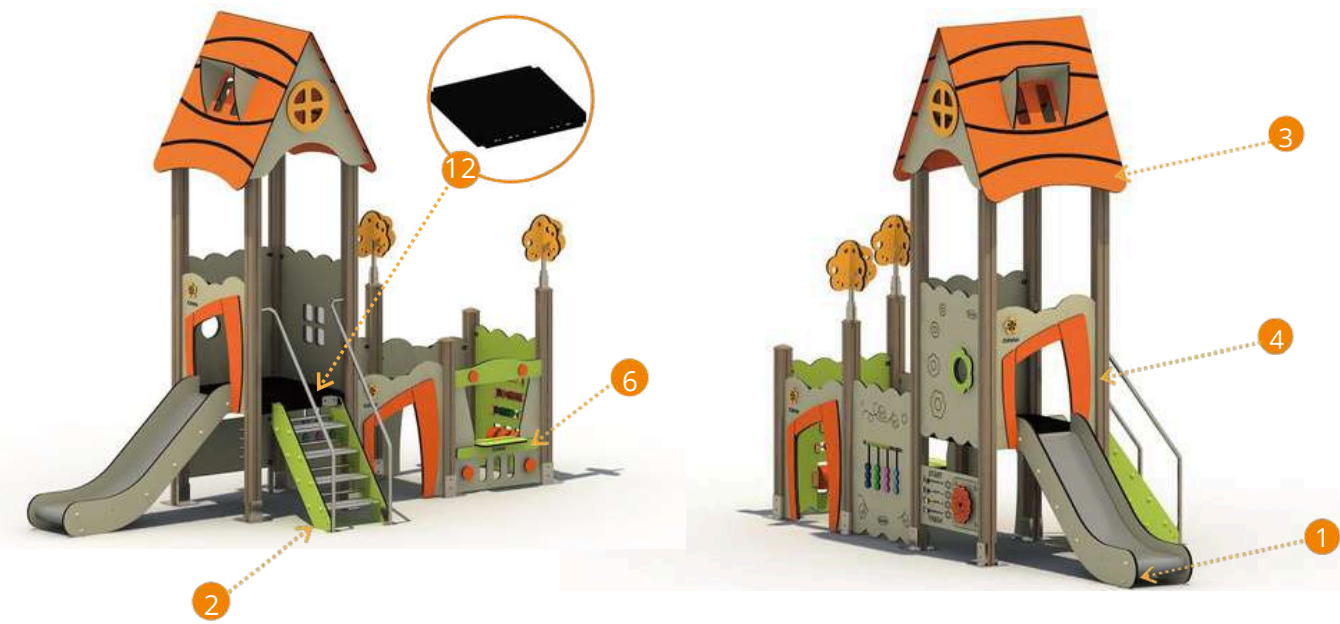

The **QualiTerra Eco Series** offers modular components for versatile play structures. Using durable HPL panels, it includes interactive game boards, windows, and doors. These seamlessly integrate with different slide units and strong support frameworks, ensuring functionality and aesthetic appeal. High-quality connectors and fasteners ensure stability and safety, making the Eco Series a flexible playground solution.

La **série QualiTerra Eco** propose des composants modulaires pour des structures de jeu polyvalentes. Utilisant des panneaux HPL durables, il comprend des panneaux de jeu interactifs, des fenêtres et des portes. Ceux-ci s'intègrent parfaitement aux différentes unités de glisse et aux cadres de support fixes, garantissant fonctionnalité et attrait esthétique. Des connecteurs et des attaches de haute qualité assurent la stabilité et la sécurité, faisant de la série Eco une solution de terrain de jeu flexible.



- 
1
 SLIDE
 (Metal, HPL plate)
- 
2
 SHORT STAIRS
 (Metal, HPL plate)
- 
3
 ROOFS
 (HPL plate)
- 
4
 DOOR FRAME
 OF SLIDE
 (HPL plate)
- 
5
 DECORATIVE
 ACCESSORIES
 (HPL plate)
- 
6
 RECEPTION
 WINDOW
 (HPL plate)
- 
7
 GAME BOARD
 (HPL plate)

- 
8
 GAME BOARD
 (HPL plate)
- 
9
 WINDOW
 (HPL plate)
- 
10
 WINDOW
 (HPL plate)
- 
11
 GAME BOARD
 (HPL plate)
- 
12
 PLATFORM
 (HDPE plate)
- 
13
 POSTS
 (Aluminum)

KOMPAKTE LAMINATPLATTE

Compact Laminate Board | Panneau stratifié compact

Unsere Kompaktlaminateplatte (HPL-Holz) zeichnet sich durch Langlebigkeit aus. Im Gegensatz zu herkömmlichem Holz oder Kunststoff ist HPL-Holz kratzfest, feuchtigkeits- und hitzebeständig und punktet durch minimalen Pflegeaufwand.

Our Compact Laminate Board (HPL wood) offers unparalleled durability, versatility, and eco-friendliness. Unlike traditional wood or plastic, HPL wood is resistant to scratches, moisture, and heat, ensuring long-lasting elegance with minimal maintenance. Its superior strength and sustainability make it the ideal choice for modern interior design and green building projects. Choose QualiTerra for quality and environmental responsibility.

Notre panneau stratifié compact (HPL) offre une durabilité, une polyvalence et un respect de l'environnement inégalés. Contrairement au bois ou au plastique traditionnel, le HPL résiste aux rayures, à l'humidité et à la chaleur, garantissant ainsi une élégance durable avec un minimum d'entretien. Sa résistance supérieure et sa durabilité en font le choix idéal pour les projets d'équipement moderne et de construction écologique. Choisissez QualiTerra pour la qualité et la responsabilité environnementale.

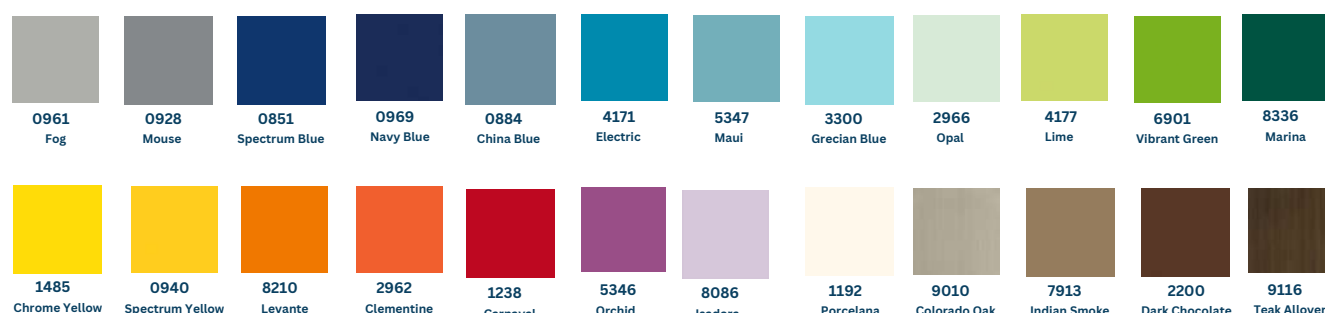
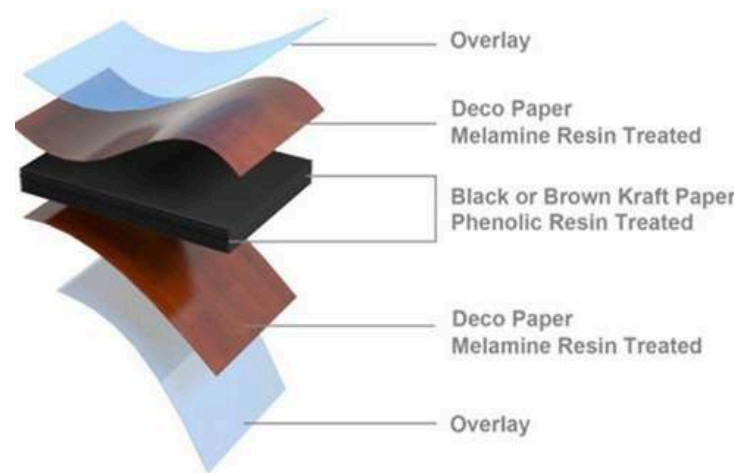

ALUMINIUMPFOSTEN IN HOLZOPTIK

Timber Look Aluminum Post | Poteaux en aluminium imitation bois

Aluminiumpfosten in Holzoptik eignen sich perfekt für Spielplatzgeräte, wenn Sie die Optik von Holz bevorzugen, aber ein langlebigeres und wartungsarmes Produkt bevorzugen. Viele entscheiden sich für die Holzoptik, um die Brandschutzkriterien zu erfüllen. Aluminium ist im Vergleich zu Holz deutlich stärker und stabiler und eignet sich daher ideal für alle Anwendungen, bei denen Haltbarkeit und Sicherheit gefragt sind.

Timber Look Aluminum Post is perfect for playground equipment if you desire the aesthetic of wood but prefer a longer-lasting, low-maintenance product. Many choose the wood look to meet fire compliance criteria, and Timber Look Aluminum Post offers a superior alternative. Compared to wood, aluminium is significantly stronger and more stable, making it ideal for any application requiring durability and safety.

Le poteau en aluminium aspect bois est parfait pour les équipements de terrains de jeux si vous désirez l'esthétique du bois mais préférez un produit plus durable et nécessitant peu d'entretien. Beaucoup choisissent l'aspect bois pour répondre aux critères de conformité au feu, et le poteau en aluminium aspect bois offre une alternative supérieure. Comparé au bois, l'aluminium est nettement plus résistant et plus stable, ce qui le rend idéal pour toute application nécessitant durabilité et sécurité.



10CM 11CM 12CM
Durchmesser der Pfosten | Diameter of the posts | Diamètre des poteaux

- ✓ **Aluminiumpfosten in Holzoptik**
Wood aesthetic meets durable aluminum
Des poteaux en aluminium imitant le bois à la perfection.
- ✓ **geringer Wartungsaufwand, einfache Instandhaltung**
Low maintenance ensures easy upkeep
Un faible entretien garantit une maintenance aisée
- ✓ **erfüllt die Brandschutzanforderung**
Fire compliance guarantees safety
La conformité incendie garantit la sécurité
- ✓ **Langlebige Stärke für Zuverlässigkeit**
Long-lasting strength for reliability
Résistance durable pour la fiabilité
- ✓ **Einfache Montage**
Simple assembly
Montage facile
- ✓ **modulare Bauweise**
Modular construction
construction modulaire



RUTSCHEN

SLIDES I TOBOGGANS

QualiTerra bietet ein breites Sortiment an Rutschen im Außenbereich.

QualiTerra offers a wide range of outdoor slides.

QualiTerra propose une large gamme de toboggans d'extérieur.

GERADE RUTSCHE I STRAIGHT SLIDE I TOBOGGAN DROIT



KUNSTSTOFF I PLASTIC



ROSTFREIER STAHL I STAINLESS STEEL

GEBOGENE RUTSCHE I CURVED SLIDE I TOBOGGAN COURBE



KUNSTSTOFF I PLASTIC



ROSTFREIER STAHL I STAINLESS STEEL

VIELE HPL- FUNKTIONSWÄNDE FÜR UNSERE SPIELTÜRME

MANY HPL FUNCTIONAL WALLS FOR OUR PLAY TOWERS DE NOMBREUSES PAROIS INTERACTIVES HPL POUR NOS TOURS DE JEUX

1 	2 	3 	4 	5 	6 
DOOR FRAME OF SLIDE (HPL plate)	RECEPTION WINDOW (HPL plate)	GAME PANEL (HPL plate)	GAME PANEL (HPL plate)	GAME PANEL (HPL plate)	GAME PANEL (HPL plate)
7 	8 	9 	10 	11 	12 
GAME PANEL (HPL plate)	WINDOW BOARD (HPL plate)	WINDOW BOARD (HPL plate)	GAME PANEL (HPL plate)	WALL BOARD (HPL plate)	MUSIC PANELS (HPL plate, aluminum tube)
13 	14 	15 	16 	17 	18 
LOW BOARD (HPL plate)	SIGN BOARD (HPL plate)	GAME PANEL (HPL plate)	GAME PANEL (HPL plate)	GAME PANEL (HPL plate)	GAME PANEL (HPL plate)
19 	20 	21 	22 	23 	24 
GAME PANEL (HPL plate)	GAME PANEL (HPL plate)	GAME PANEL (HPL plate)	WINDOW BOARD (HPL plate)	WINDOW BOARD (HPL plate)	WINDOW BOARD (HPL plate)
25 	26 	27 	28 	29 	30 
WINDOW BOARD (HPL plate)	GAME PANEL (HPL plate)	WINDOW BOARD (HPL plate)	WINDOW BOARD (HPL plate)	WINDOW BOARD (HPL plate)	GAME PANEL (HPL plate)



SPACE THEME

Spielplatz mit Weltraumthema, in dessen Mittelpunkt eine zweistufige Raketenrutsche steht, die durch ein Karussell in UFO-Form, ein Seilnetz in Form eines Weltraumbergs und eine Doppelschaukel mit klaren Linien ergänzt wird.

Space-themed playground, with a two-tier rocket slide combination as the centerpiece, complemented by a UFO-shaped merry-go-round, space mountain-shaped rope net and a double-person swing with clean lines.

Aire de jeux sur le thème de l'espace, avec une combinaison de toboggans-fusées à deux niveaux comme pièce maîtresse, complétée par un manège en forme d'OVNI, un filet de corde en forme de montagne spatiale et un balançoire pour deux personnes aux lignes épurées.



GW-06101

UNIT SIZE: CM 590*620*690
SAFETY ZONE 1000*1000 CM



S-20242

UNIT SIZE: 350*120*230cm



NC18802

UNIT SIZE: 530*530*400 cm
SAFETY ZONE 890*890 cm



RP-20804

UNIT SIZE: 220*220*84cm

OCEAN ADVENTURE PARK

Fesselndes Meererlebnis mit dem Themenpark am Meer mit Piratenschiff, Tiefsee-Kletterfelsen, Schaukel, Ballseilnetz, Quallen- karussell, Federwippen Hai, Octopus und Robbe.

Ocean-themed park featuring a pirate ship slide, deep-sea rock climbing, Swing set, ball rope net, jellyfish carousel, whale rocking board, and marine life-shaped rocking horse. Offers a captivating ocean experience.

Parc sur le thème de l'océan comprenant proposant un toboggan de bateau pirate, de l'escalade en haute mer, une balançoire, un filet de corde à balles, un carrousel de méduses, une planche à bascule de baleine et un cheval à bascule en forme de vie marine. Offre une expérience océanique captivante.

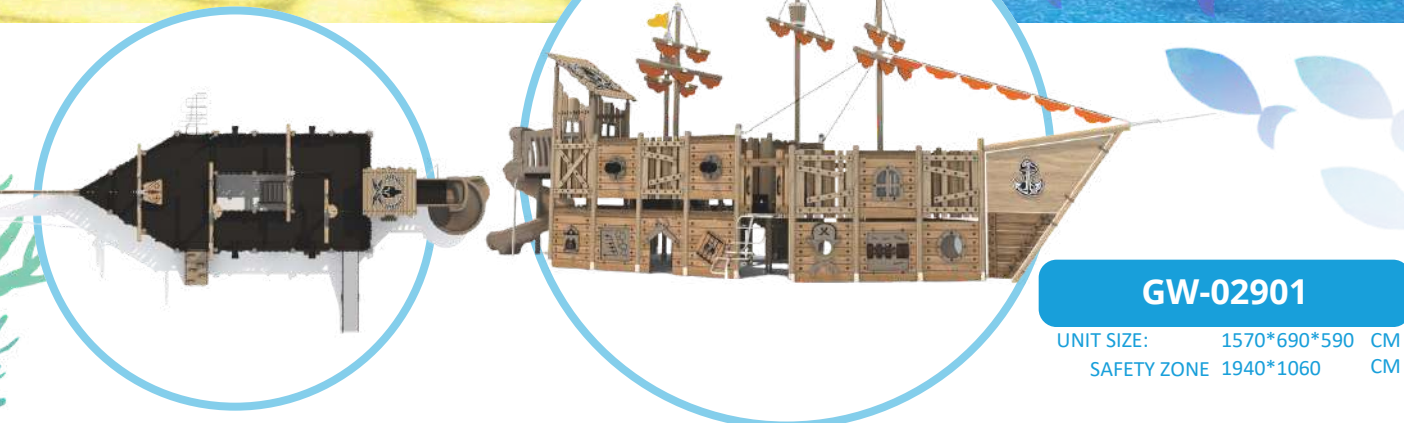
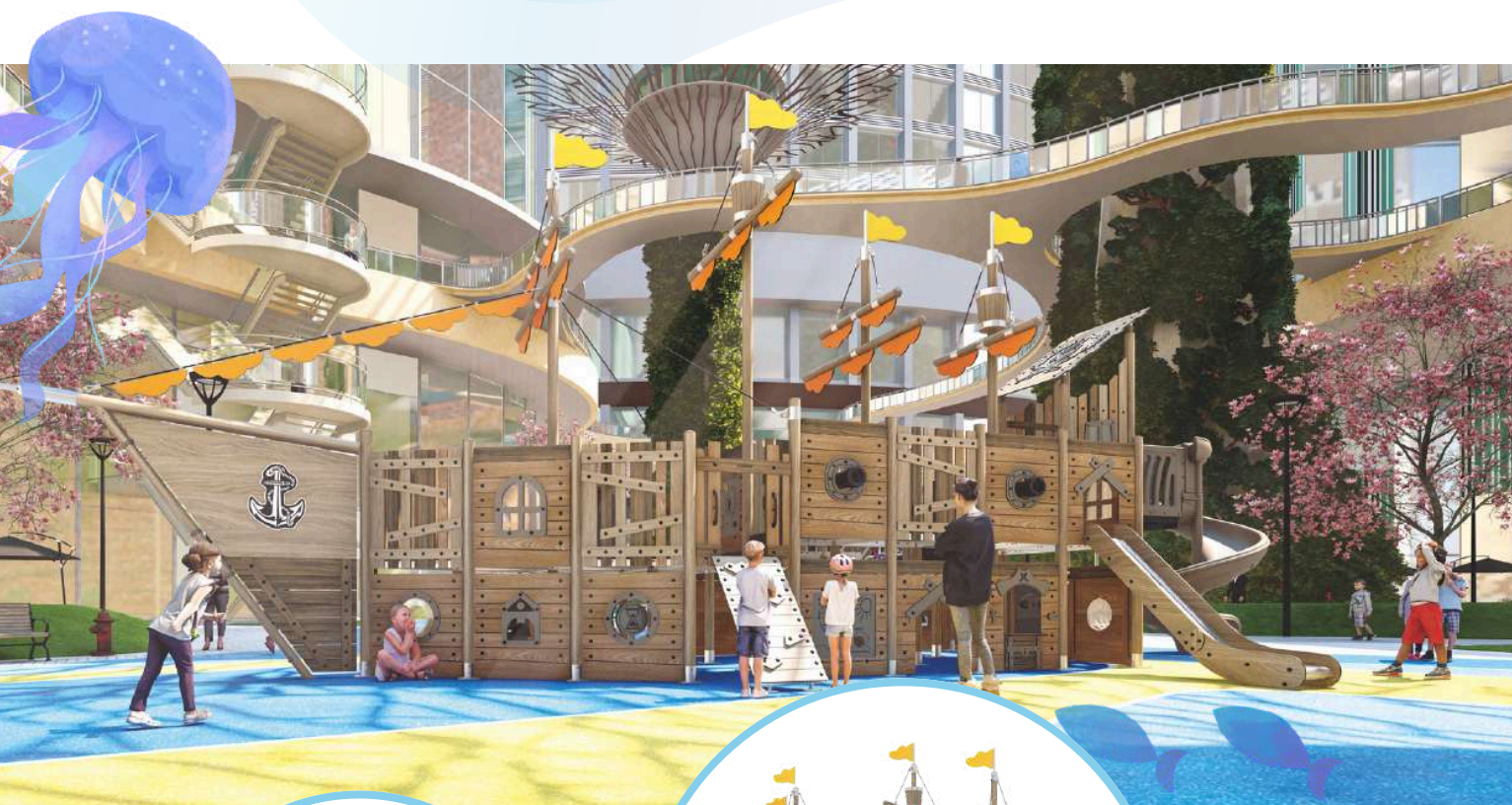

GW-02901
UNIT SIZE: 1570*690*590 CM
SAFETY ZONE 1940*1060 CM

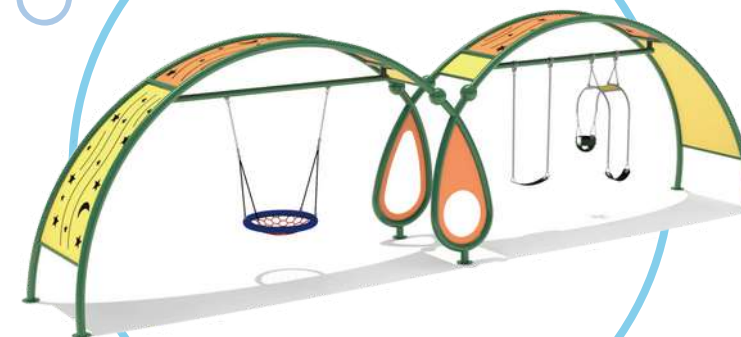

S-20301
UNIT SIZE: 1160*160*330cm



RC-19202
UNIT SIZE: 480*460*220 CM
SAFETY ZONE 850*830 CM

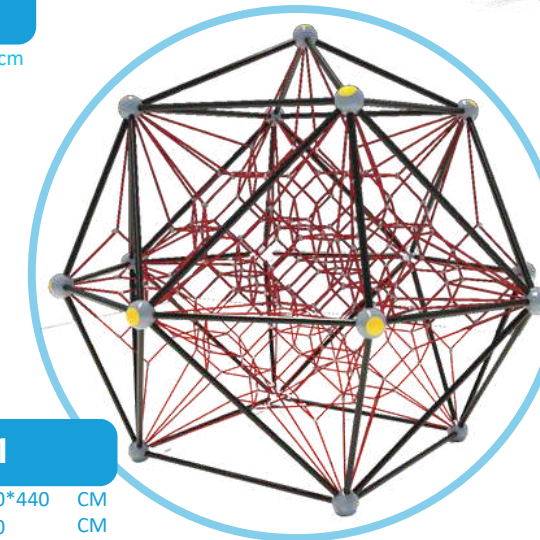

NC-18701
UNIT SIZE: 510*510*440 CM
SAFETY ZONE 870*870 CM



ES-20106
UNIT SIZE: 316*58*83cm

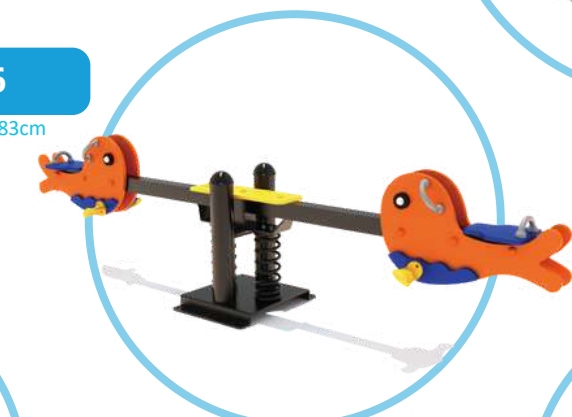

RP-20702
UNIT SIZE: 200*190*200cm



PE-SR-19901
UNIT SIZE: 91*36*84cm



PE-SR-19902
UNIT SIZE: 72*36*85cm



PE-SR-19905
UNIT SIZE: 81*42*100cm

NATURE THEME PLAYGROUND



Der **Naturspielplatz** verfügt über ein riesiges Abenteuer-Baumhaus, großes Klettergerüst, Kletterfelsen, Pflanzenkarussell, Tipi, Federwippgerät Blume, Schmetterlingschaukel, Ast-Schwebebalken und Pflanzenwippe.

The **nature-themed** playground features a 2 treehouse slide, large climbing frame, rock climbing set, plant-themed carousel, camp-style treehouse, butterfly swing, tree branch balance beam, and plant seesaw. Offers children play and nature exploration!

L'**aire de jeux** sur le thème de la nature propose 2 toboggans dans les arbres, un grand portique d'escalade, un ensemble d'escalade, un carrousel sur le thème des plantes, une cabane dans les arbres de style camp, une balançoire papillon, une poutre d'équilibre en branches d'arbre et une balançoire végétale. Offre aux enfants du jeu et de l'exploration de la nature !



GW-01801

UNIT SIZE: 1060*650*550 CM
SAFETY ZONE 1430*1020 CM

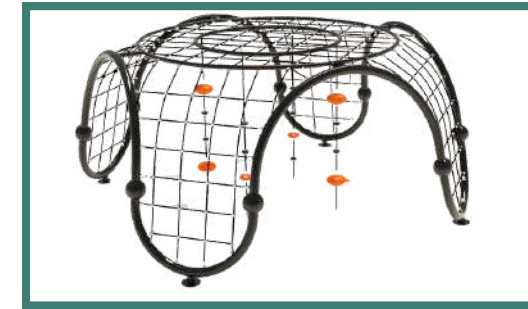

NC-18702

UNIT SIZE: 560*560*240 CM
SAFETY ZONE 920*920 CM

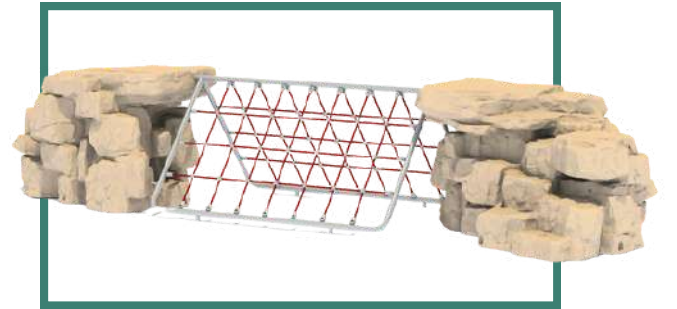

RC-18904

UNIT SIZE: 990*570CM



RP-20703

UNIT SIZE: 200*190*300CM



PE-17404

UNIT SIZE: 200*190*210CM



PE-SR-19906

UNIT SIZE: 64*42*81CM



S-20401

UNIT SIZE: 170*150*300CM



RP-20603

UNIT SIZE: 271*93*46CM

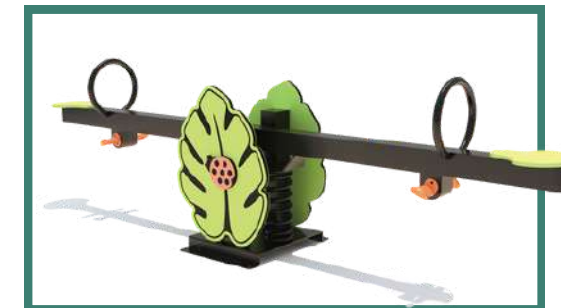

ES-20101

UNIT SIZE: 313*61*88CM

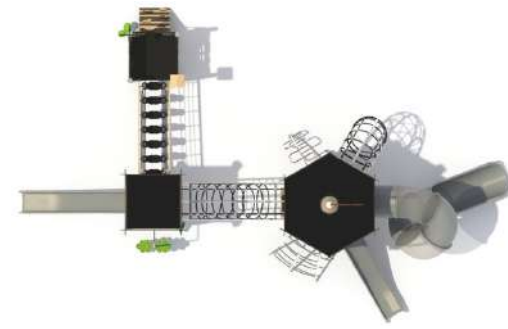

GW-00301
 UNIT SIZE: 1130*740*730 CM
 SAFETY ZONE 1500*1100 CM

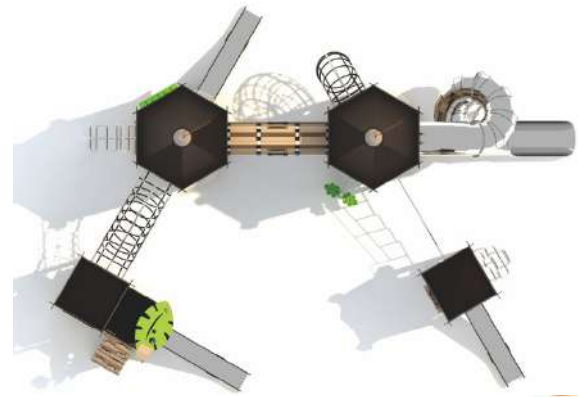

GW-00201
 UNIT SIZE: 1120*880*760 CM
 SAFETY ZONE 1490*1250 CM





GW-00401

UNIT SIZE: 1060*410*480 CM
SAFETY ZONE 1430*780 CM

GW-00501

UNIT SIZE: 1280*650*600 CM
SAFETY ZONE 1650*1020 CM

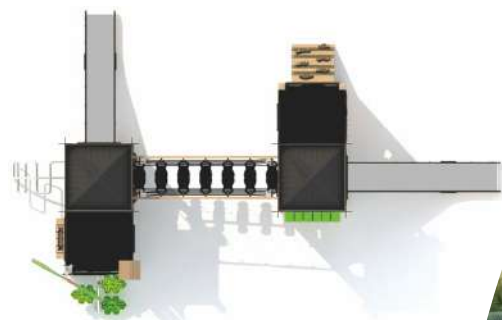
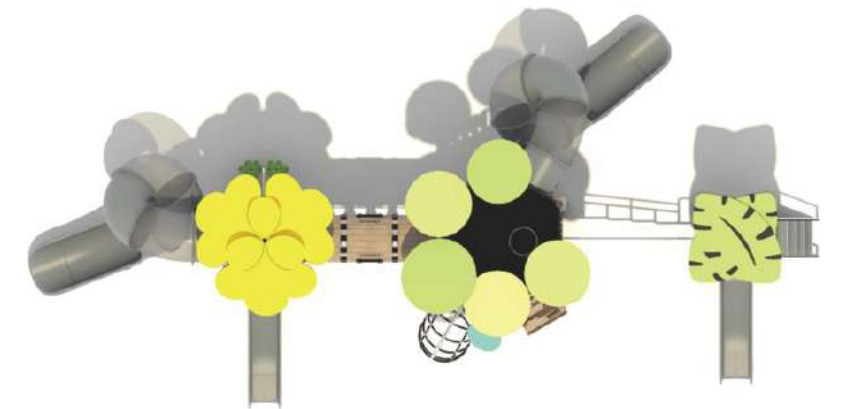

GW-00402

UNIT SIZE: 810*500*480 CM
SAFETY ZONE 1180*870 CM





GW-00701

UNIT SIZE: 1050*750*540 CM
SAFETY ZONE 1420*1120 CM

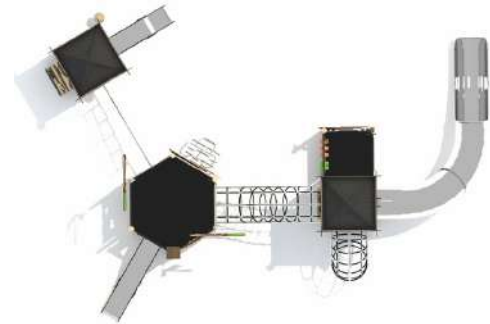
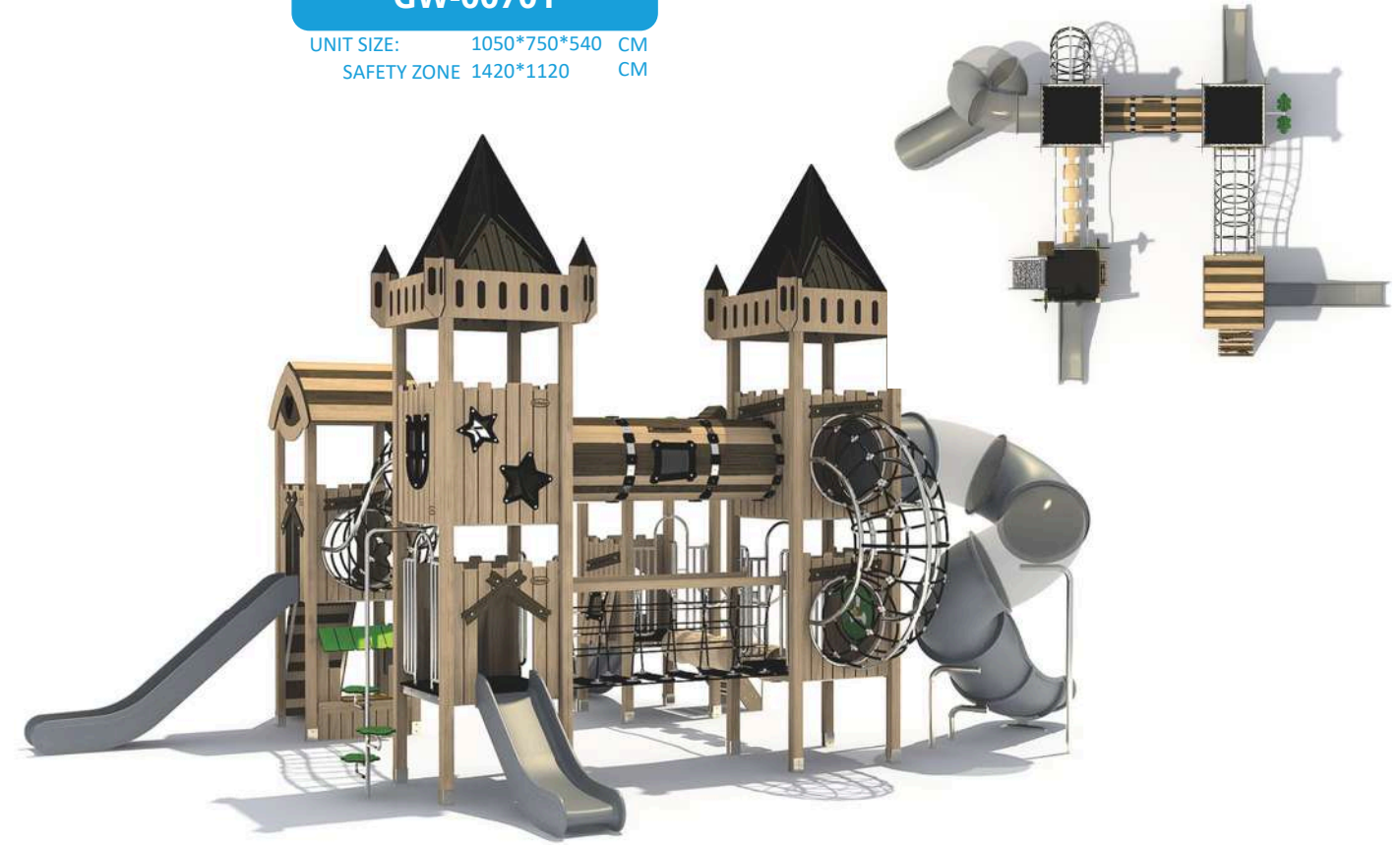

GW-00601

UNIT SIZE: 1020*730*540 CM
SAFETY ZONE 1390*1100 CM



CASTLES

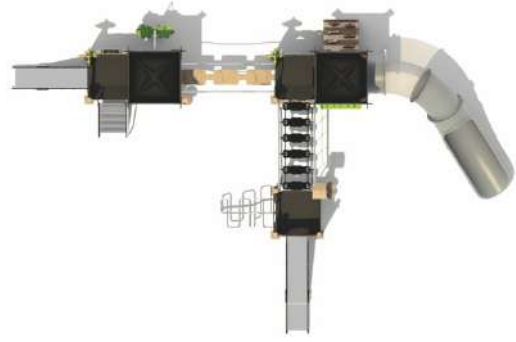

GW-00801

UNIT SIZE: 1180*730*480 CM
SAFETY ZONE 1550*1100 CM

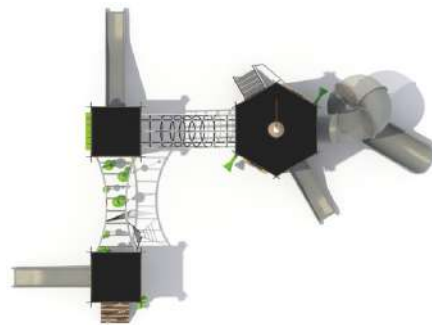

GW-00802

UNIT SIZE: 1080*800*700 CM
SAFETY ZONE 1450*1170 CM

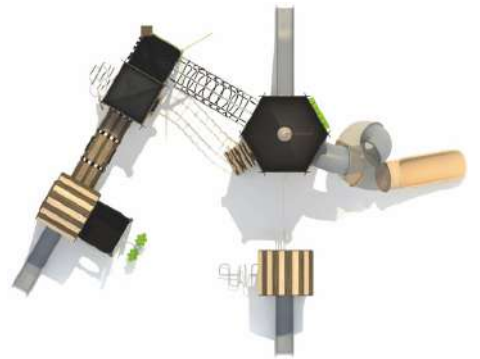

GW-00901

UNIT SIZE: 1270*960*760 CM
SAFETY ZONE 1640*1330 CM



JUNGLE

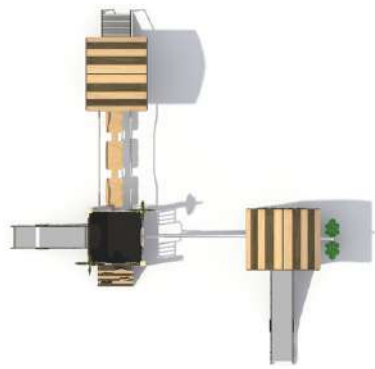

GW-01001

UNIT SIZE: 740*670*360 CM
SAFETY ZONE 1040*1100 CM

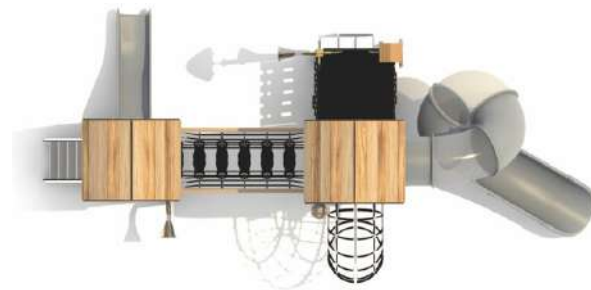

GW-01002

UNIT SIZE: 860*400*480 CM
SAFETY ZONE 1230*770 CM

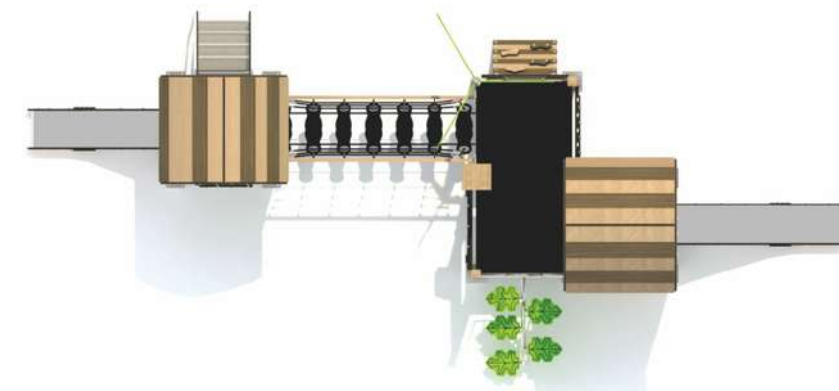

GW-01101

UNIT SIZE: 940*420*360 CM
SAFETY ZONE 1300*790 CM

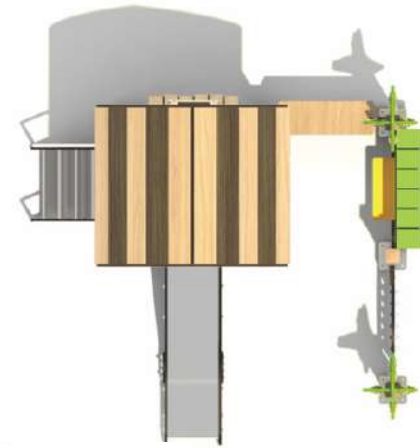

GW-01201

UNIT SIZE: 310*280*330 CM
SAFETY ZONE 680*650 CM



GW-01301

UNIT SIZE: 1280*770*570 CM
SAFETY ZONE 1650*1140 CM

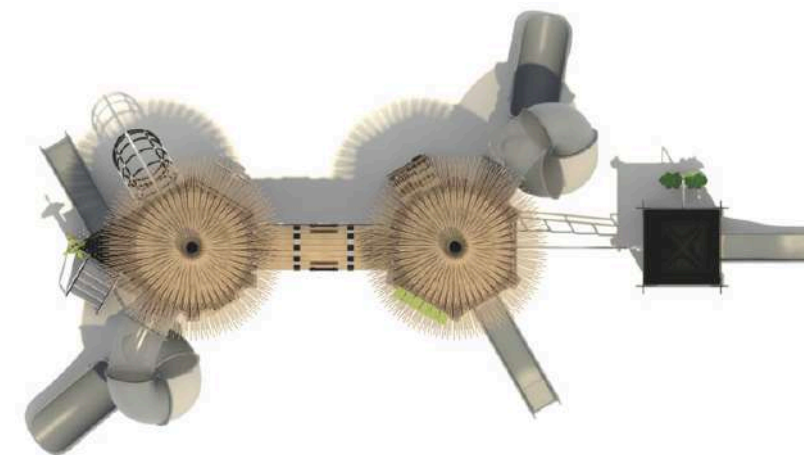

GW-01202

UNIT SIZE: 450*270*360 CM
SAFETY ZONE 820*640 CM

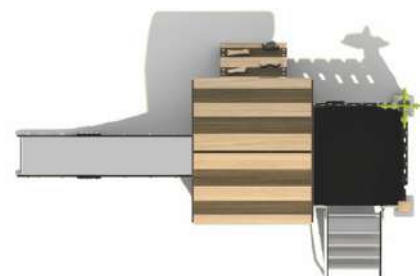



GW-01401

UNIT SIZE: 1200*700*540 CM
SAFETY ZONE 1570*1070 CM



GW-01402

UNIT SIZE: 900*820*600 CM
SAFETY ZONE 1270*1190 CM



GW-01601

UNIT SIZE: 1180*990*610 CM
SAFETY ZONE 1550*1360 CM



GW-01801
 UNIT SIZE: 1060*650*550 CM
 SAFETY ZONE 1430*1020 CM

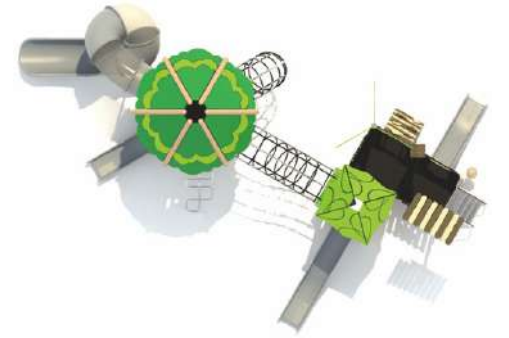

GW-01701
 UNIT SIZE: 1250*650*550 CM
 SAFETY ZONE 1620*1020 CM

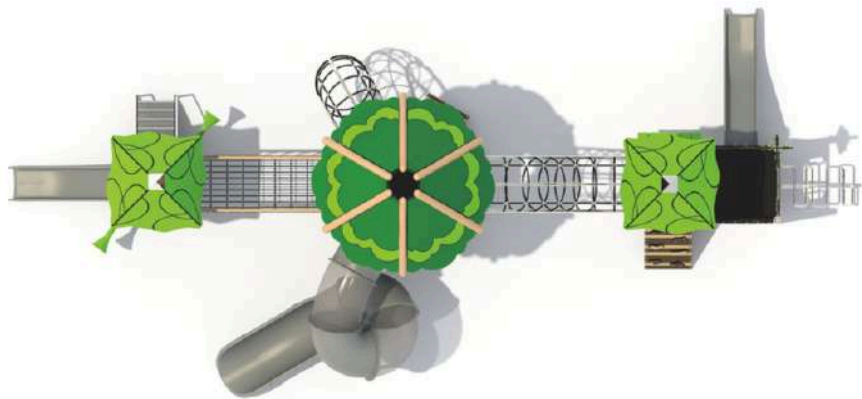

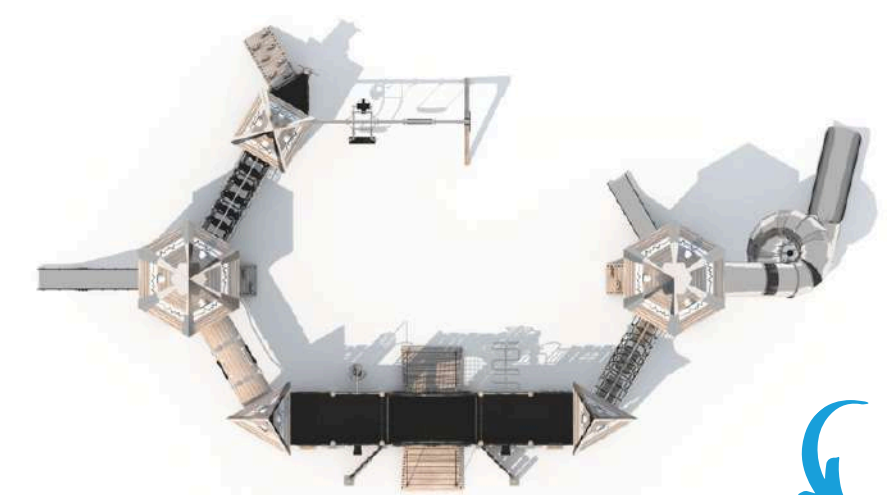

GW-02101

UNIT SIZE: 1880*980*670 CM
SAFETY ZONE 2250*1350 CM

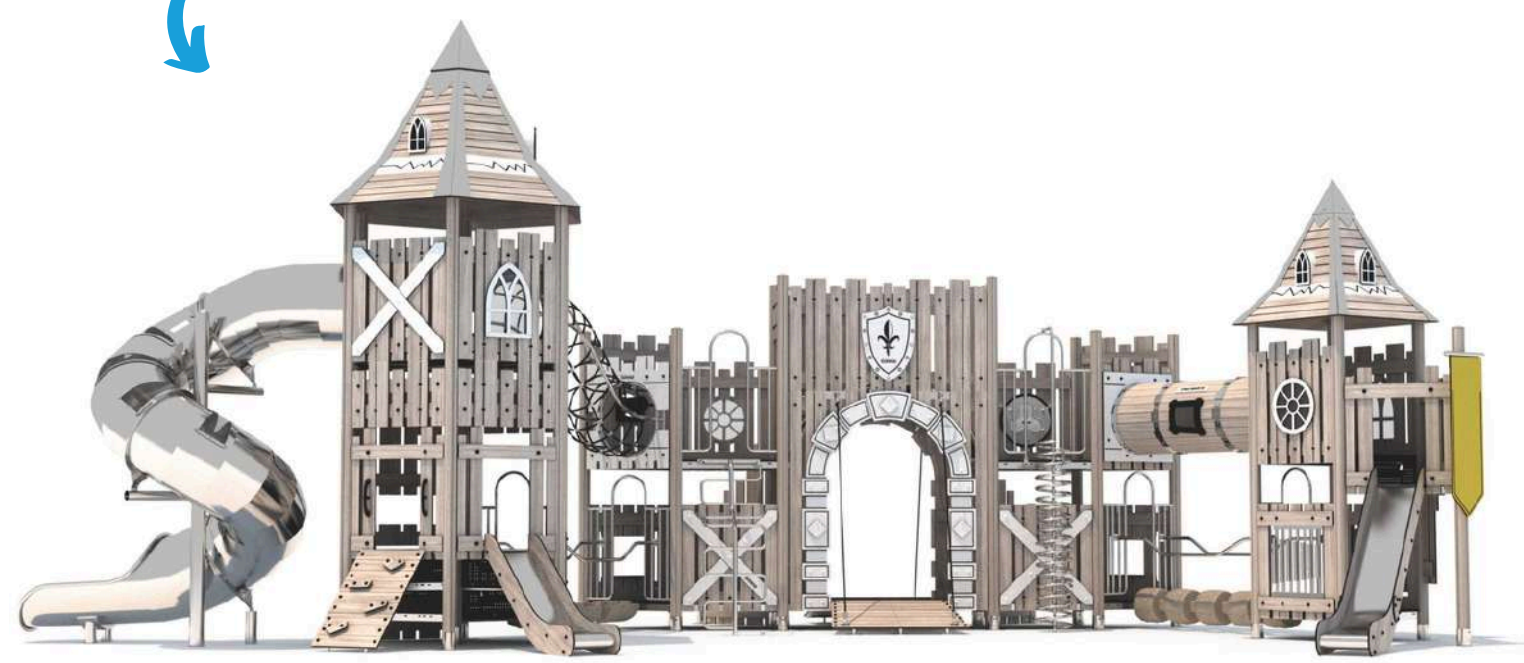

GW-02001

UNIT SIZE: 1360*790*600 CM
SAFETY ZONE 1730*1160 CM

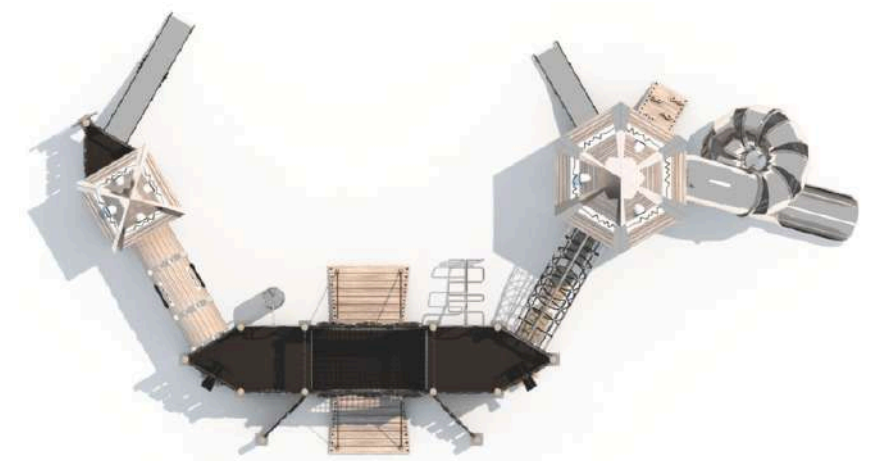



GW-02401

UNIT SIZE: 730*550*510 CM
SAFETY ZONE 1100*920 CM



GW-02301

UNIT SIZE: 1260*790*530 CM
SAFETY ZONE 1160*1360 CM



GW-02402

UNIT SIZE: 670*450*460 CM
SAFETY ZONE 1040*820 CM



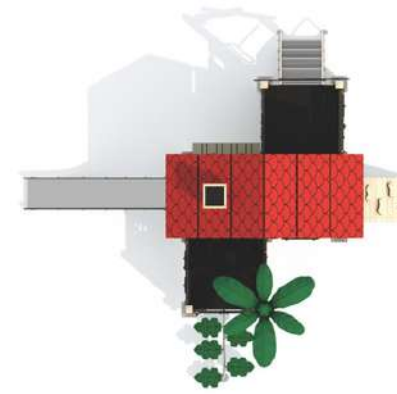

GW-02701
 UNIT SIZE: 580*530*470 CM
 SAFETY ZONE 950*900 CM



GW-02501
 UNIT SIZE: 850*840*550 CM
 SAFETY ZONE 1220*1200 CM



GW-02702
 UNIT SIZE: 740*630*520 CM
 SAFETY ZONE 1000*1100 CM

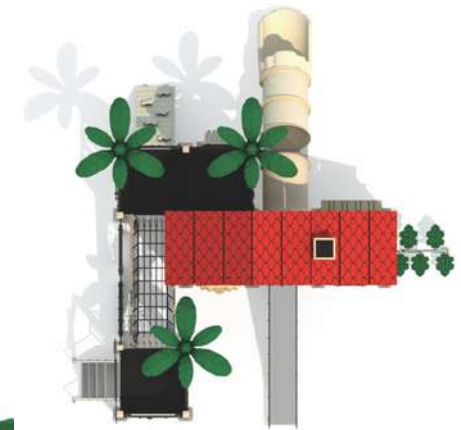



GW-02901

UNIT SIZE: 1570*690*590 CM
SAFETY ZONE 1940*1060 CM

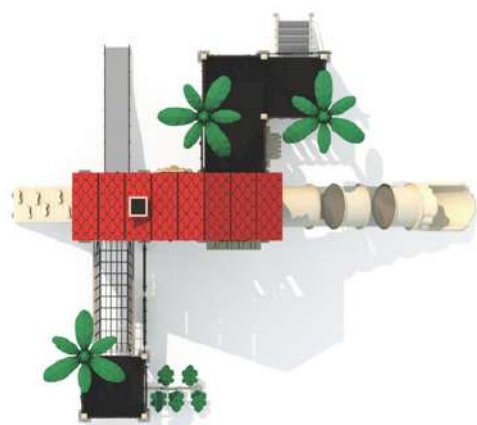

GW-02801

UNIT SIZE: 2000*790*800 CM
SAFETY ZONE 1200*1120 CM



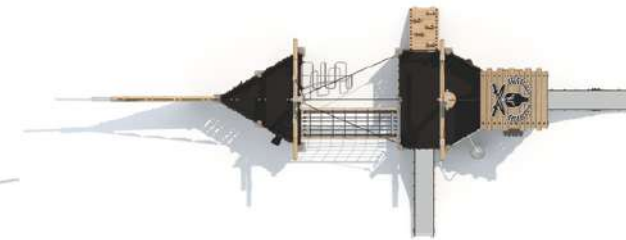

GW-03201

UNIT SIZE: 1350*530*570 CM
SAFETY ZONE 1720*900 CM

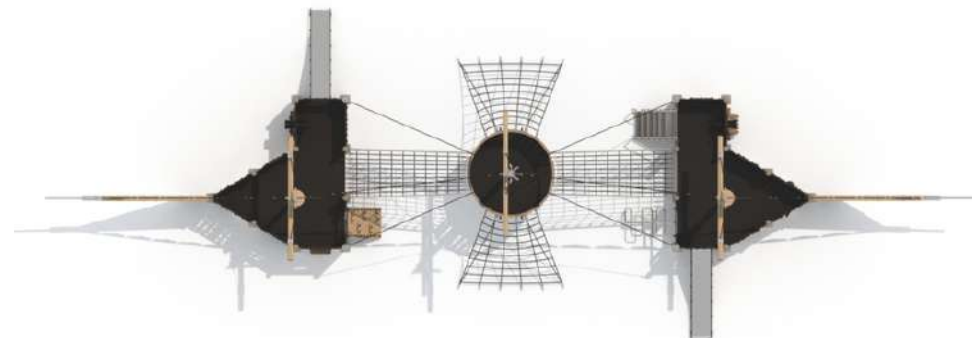

GW-03101

UNIT SIZE: 2000*790*800 CM
SAFETY ZONE 2370*1160 CM

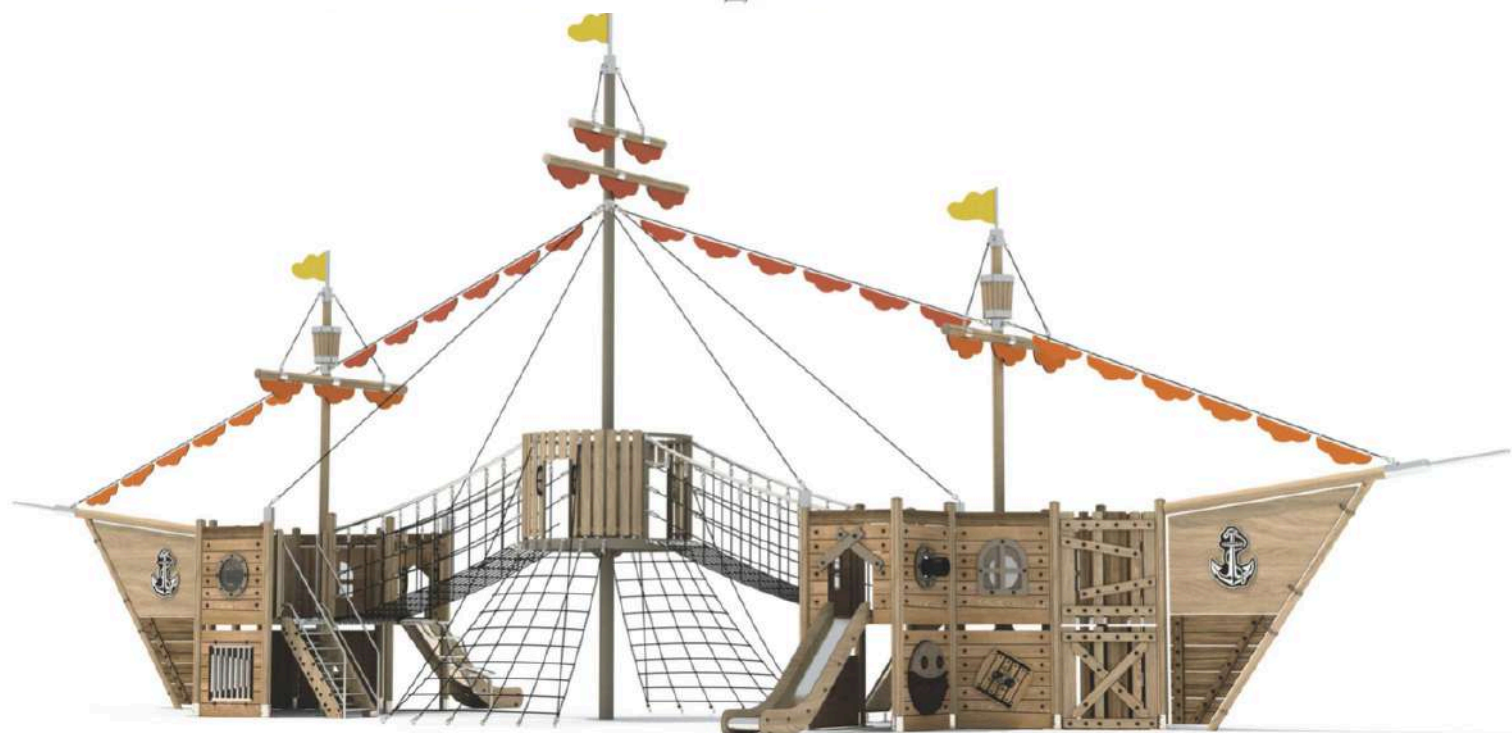

GW-03202

UNIT SIZE: 1230*670*630 CM
SAFETY ZONE 1600*1040 CM

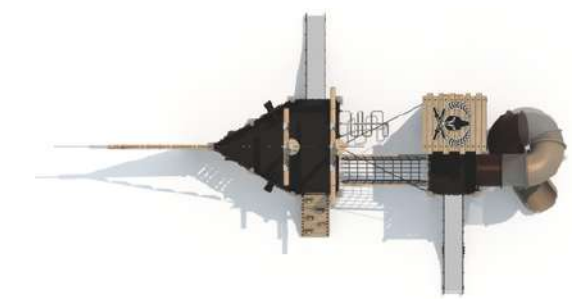



GW-03501

UNIT SIZE: 830*540*470 CM
SAFETY ZONE 1200*900 CM

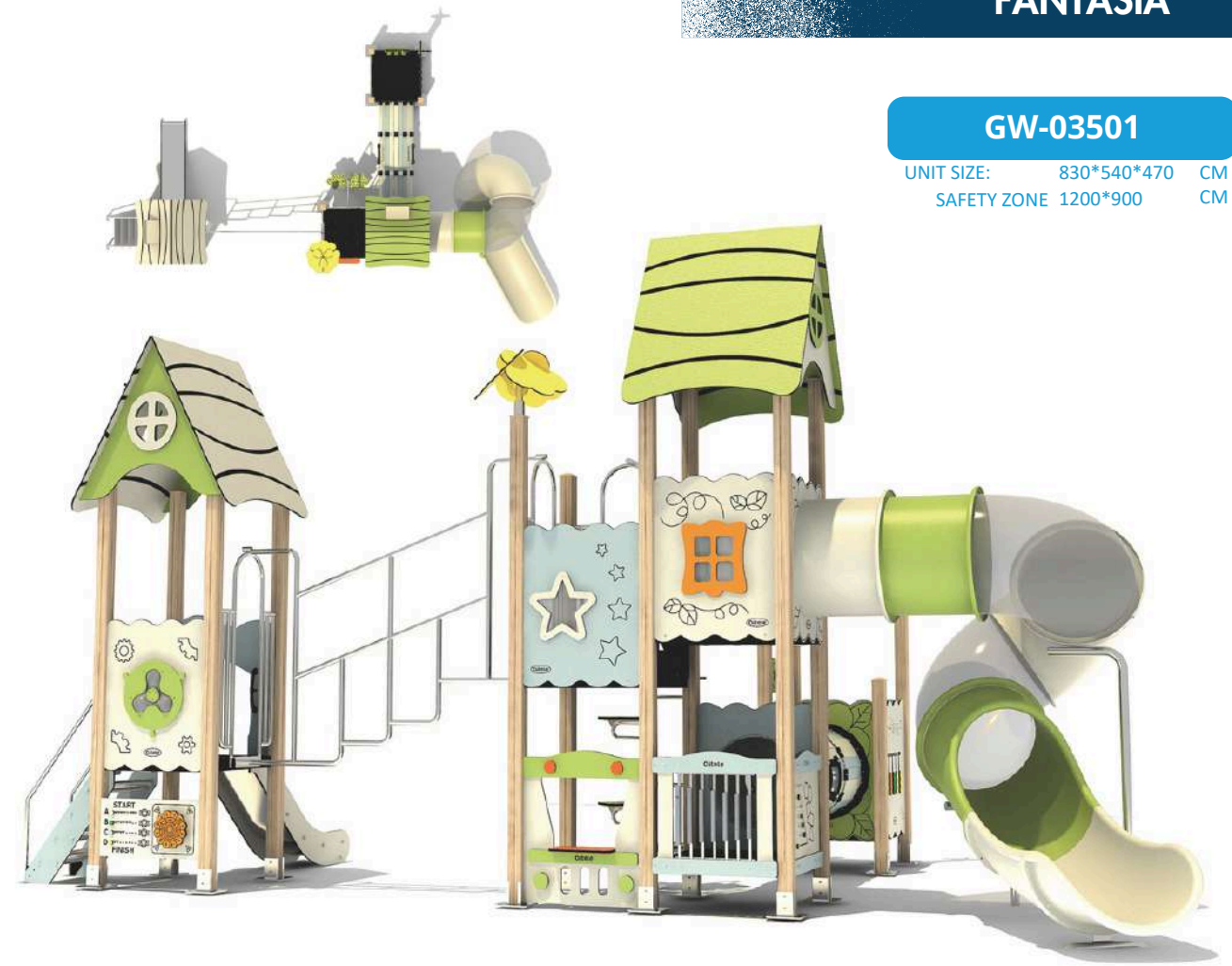

GW-03301

UNIT SIZE: 940*750*530 CM
SAFETY ZONE 1120*1310 CM

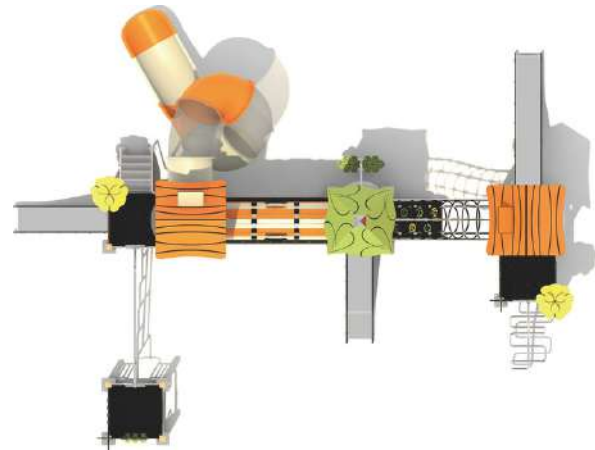

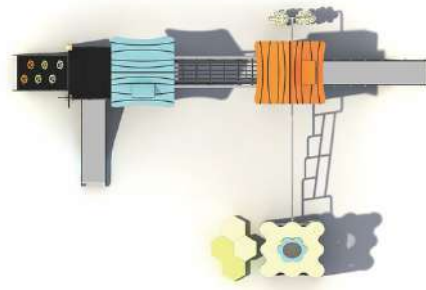

GW-03601

UNIT SIZE: 790*470*410 CM
SAFETY ZONE 1160*840 CM

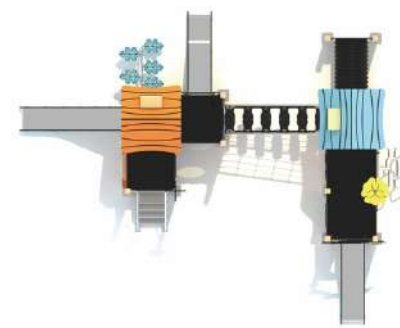

GW-03701

UNIT SIZE: 760*610*440 CM
SAFETY ZONE 1130*980 CM

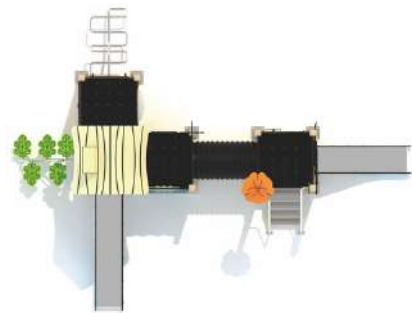

GW-03602

UNIT SIZE: 680*500*410 CM
SAFETY ZONE 1050*870 CM

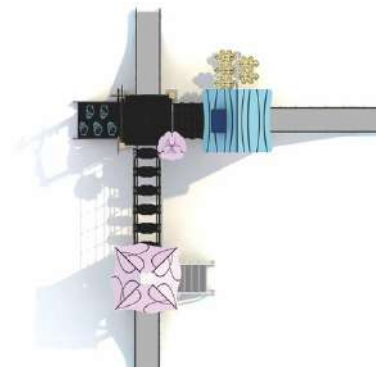

GW-03702

UNIT SIZE: 710*640*440 CM
SAFETY ZONE 1000*1080 CM





GW-03901

UNIT SIZE: 380*270*380 CM
SAFETY ZONE 750*640 CM

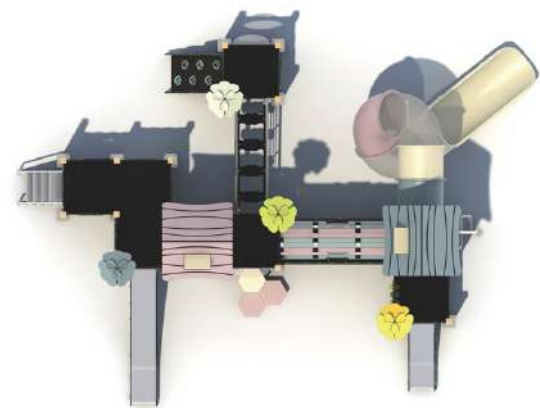

GW-03801

UNIT SIZE: 890*670*500 CM
SAFETY ZONE 1260*1040 CM



GW-03902

UNIT SIZE: 490*200*290 CM
SAFETY ZONE 860*570 CM





GW-04201

UNIT SIZE: 1020*770*560 CM
SAFETY ZONE 1390*1140 CM

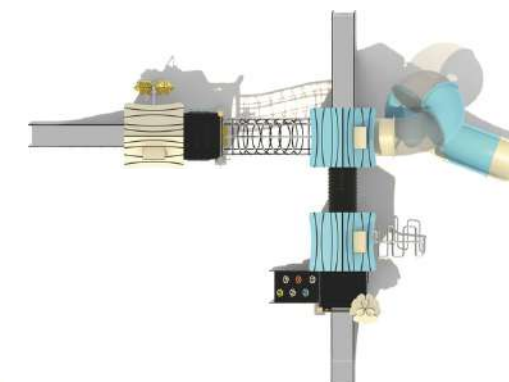

GW-04001

UNIT SIZE: 780*690*530 CM
SAFETY ZONE 1060*1150 CM

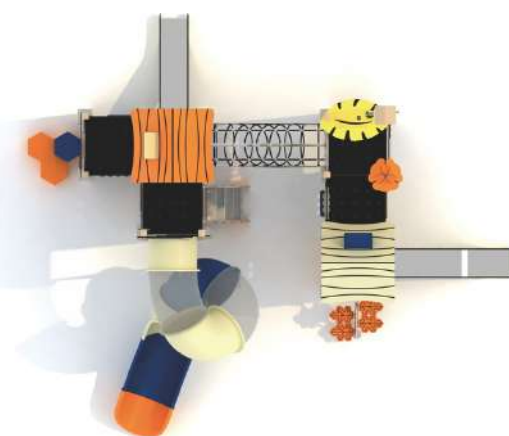

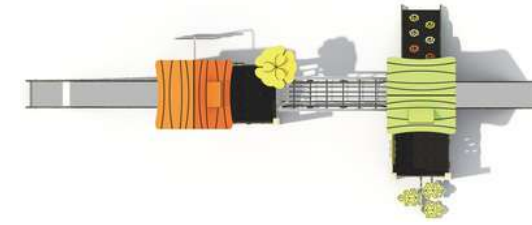

GW-04401

UNIT SIZE: 920*350*440 CM
SAFETY ZONE 1290*720 CM

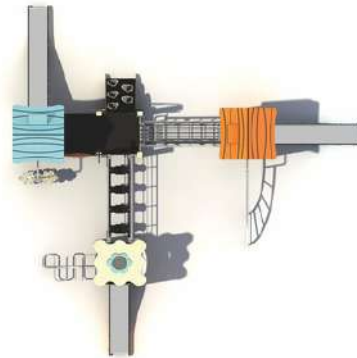

GW-04301

UNIT SIZE: 820*790*440 CM
SAFETY ZONE 1160*1190 CM

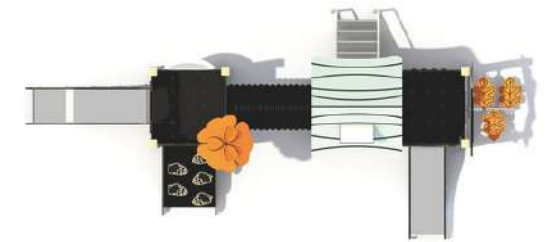

GW-04402

UNIT SIZE: 630*300*380 CM
SAFETY ZONE 1000*670 CM



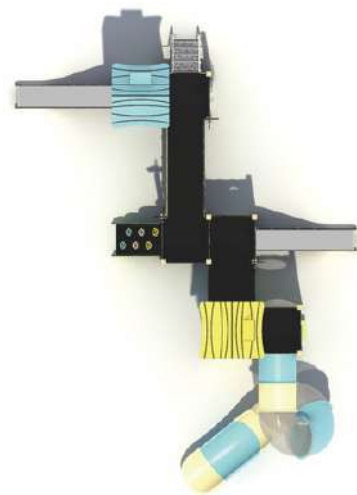

GW-04601

UNIT SIZE: 900*700*500 CM
SAFETY ZONE 1270*1070 CM

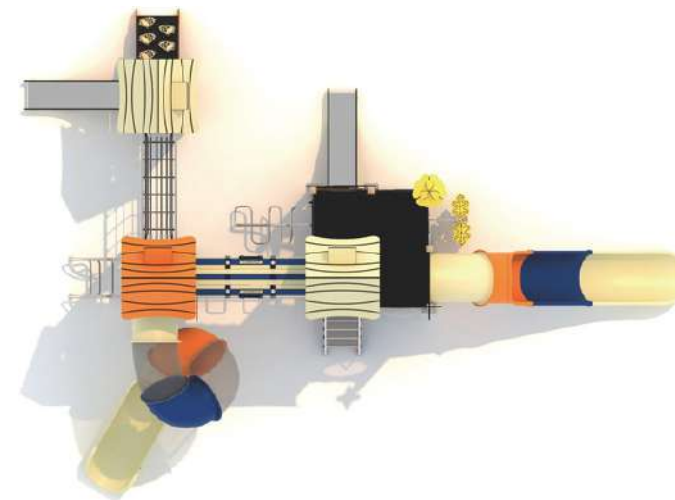

GW-04701

UNIT SIZE: 1100*820*530 CM
SAFETY ZONE 1470*1190 CM

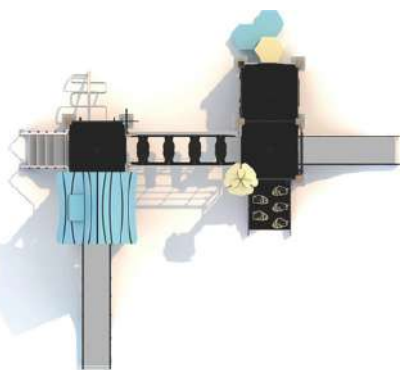

GW-04602

UNIT SIZE: 630*580*410 CM
SAFETY ZONE 1000*950 CM



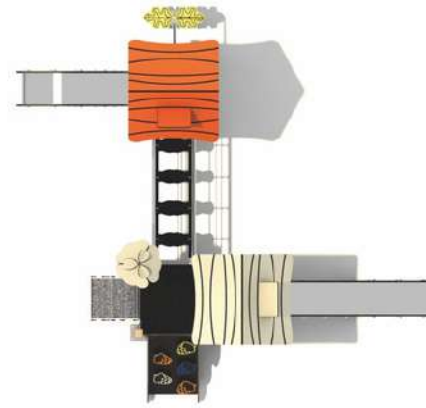

GW-04901

UNIT SIZE: 560*560*410 CM
SAFETY ZONE 930*930 CM



GW-05001

UNIT SIZE: 920*630*530 CM
SAFETY ZONE 1290*1000 CM

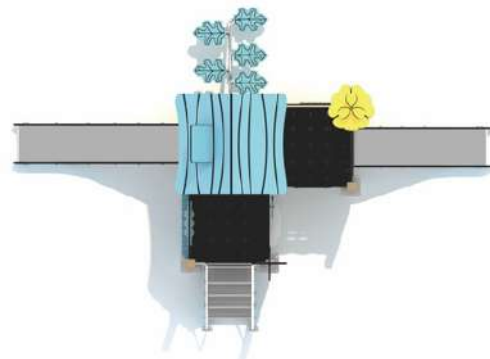

GW-04902

UNIT SIZE: 560*390*410 CM
SAFETY ZONE 760*930 CM

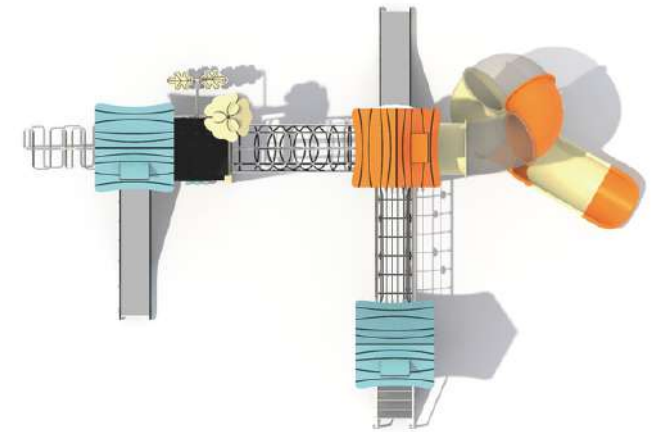

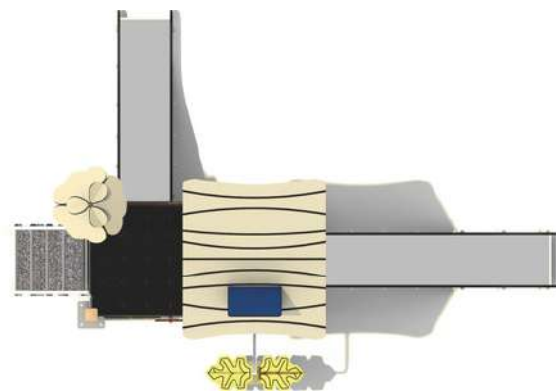

GW-05101

UNIT SIZE: 480*320*410 CM
SAFETY ZONE 850*690 CM

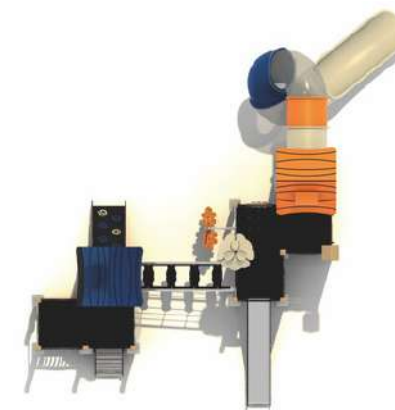

GW-05201

UNIT SIZE: 720*740*500 CM
SAFETY ZONE 1100*1090 CM



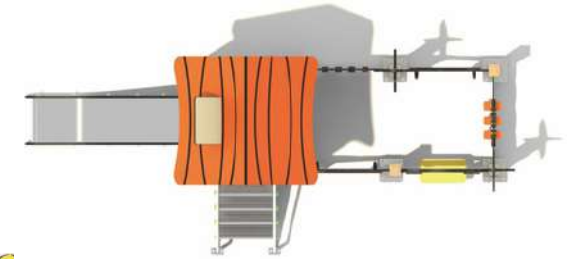

GW-05401
 UNIT SIZE: 450*180*380 CM
 SAFETY ZONE 820*550 CM

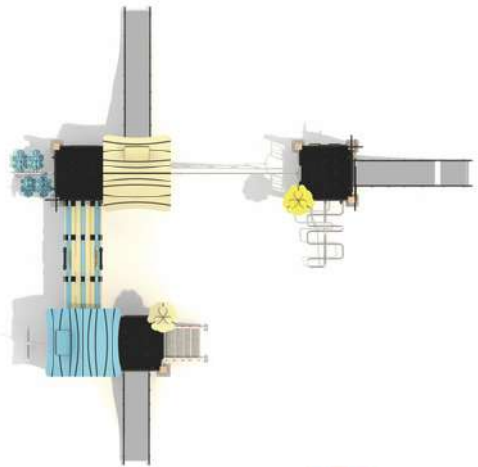

GW-05301
 UNIT SIZE: 820*790*440 CM
 SAFETY ZONE 1160*1190 CM



GW-05402
 UNIT SIZE: 620*480*410 CM
 SAFETY ZONE 990*850 CM

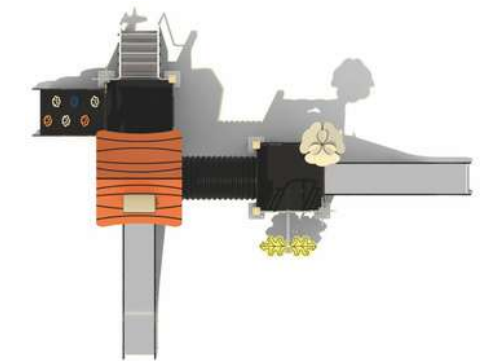

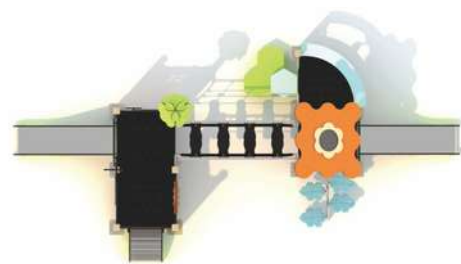

GW-05501
 UNIT SIZE: 350*700*350 CM
 SAFETY ZONE 720*1070 CM



GW-05601
 UNIT SIZE: 450*400*380 CM
 SAFETY ZONE 820*770 CM

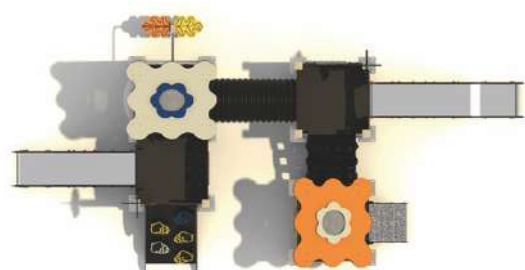

GW-05502
 UNIT SIZE: 360*660*380 CM
 SAFETY ZONE 730*1030 CM

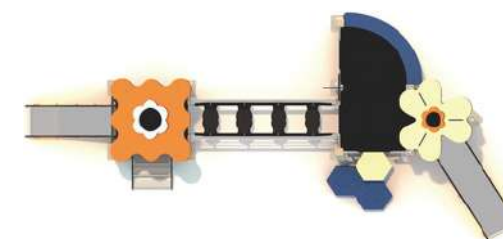

GW-05602
 UNIT SIZE: 330*640*350 CM
 SAFETY ZONE 700*1000 CM



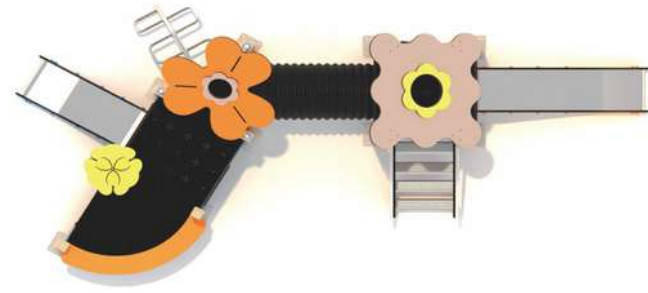

GW-05701

UNIT SIZE: 290*580*350 CM
SAFETY ZONE 660*950 CM

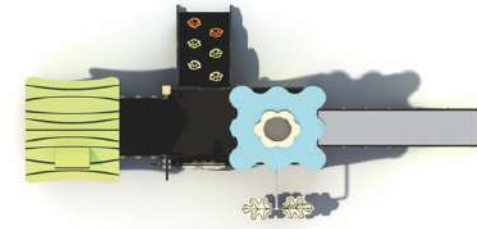

GW-05801

UNIT SIZE: 270*570*380 CM
SAFETY ZONE 640*940 CM

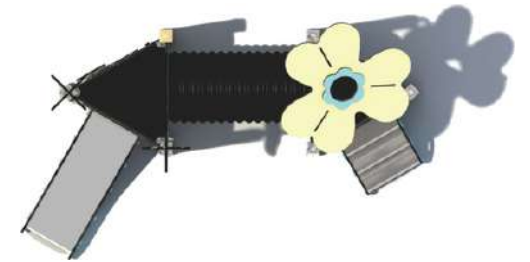

GW-05802

UNIT SIZE: 200*330*320 CM
SAFETY ZONE 570*700 CM

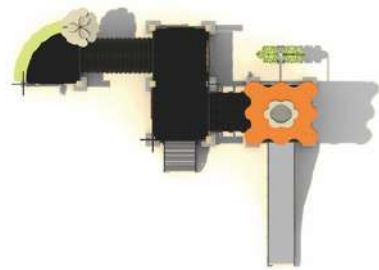

GW-05702

UNIT SIZE: 400*470*390 CM
SAFETY ZONE 770*840 CM

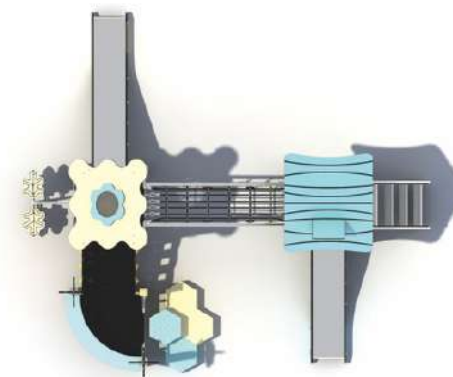

GW-05803

UNIT SIZE: 480*520*380 CM
SAFETY ZONE 850*890 CM



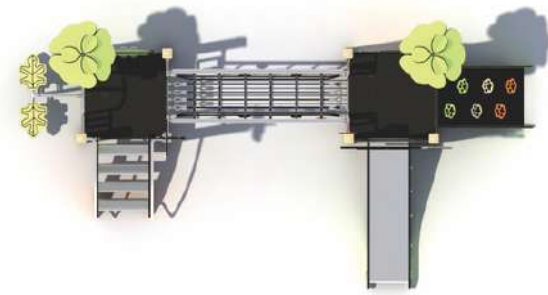

GW-05901

UNIT SIZE: 260*540*330 CM
SAFETY ZONE 630*910 CM

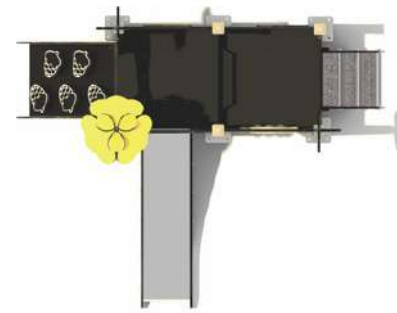

GW-06001

UNIT SIZE: 260*350*330 CM
SAFETY ZONE 630*720 CM



GW-05902

UNIT SIZE: 280*540*350 CM
SAFETY ZONE 650*900 CM

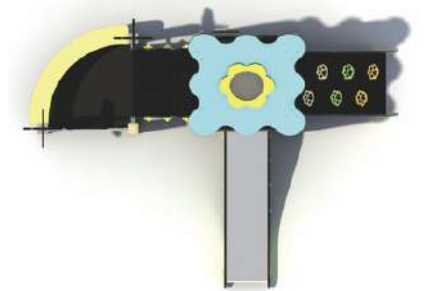

GW-06002

UNIT SIZE: 270*380*350 CM
SAFETY ZONE 640*750 CM

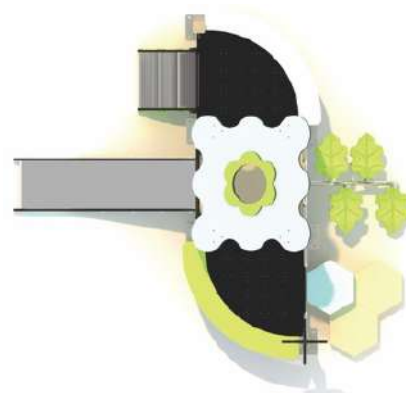

GW-05903

UNIT SIZE: 310*350*350 CM
SAFETY ZONE 680*720 CM

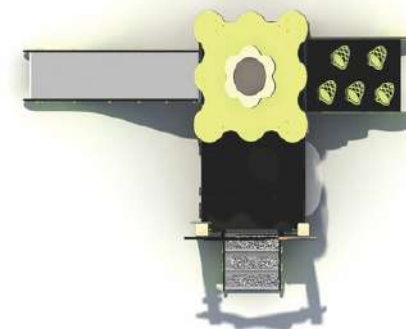

GW-06003

UNIT SIZE: 360*250*350 CM
SAFETY ZONE 730*620 CM



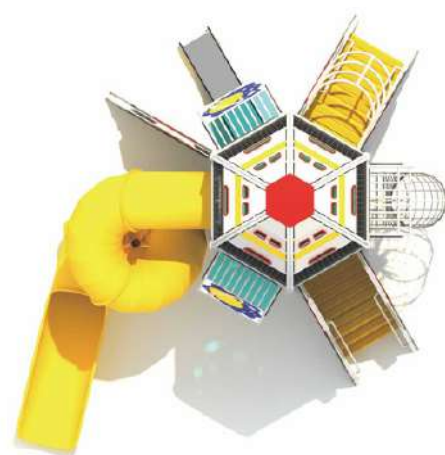

GW-06101

UNIT SIZE: 590*620*690 CM
SAFETY ZONE 1000*1000 CM

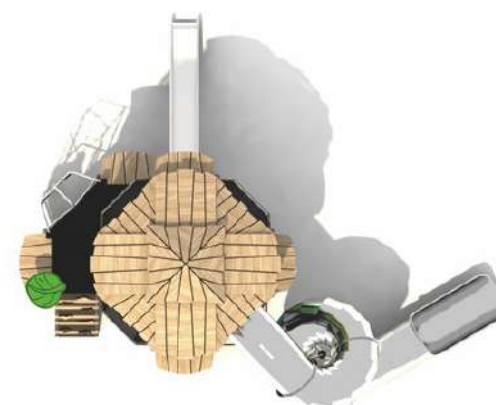

GW-06201

UNIT SIZE: 830*710*670 CM
SAFETY ZONE 1200*1100 CM





NC-18801

UNIT SIZE: 510*510*540 CM
SAFETY ZONE 870*870 CM

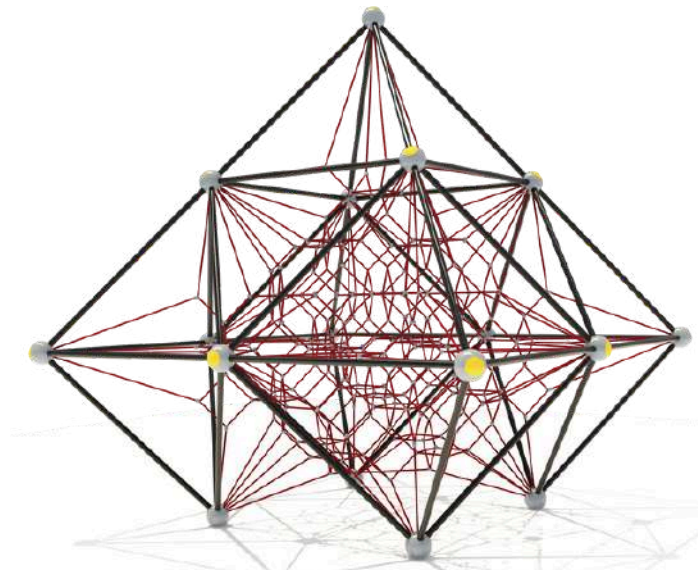
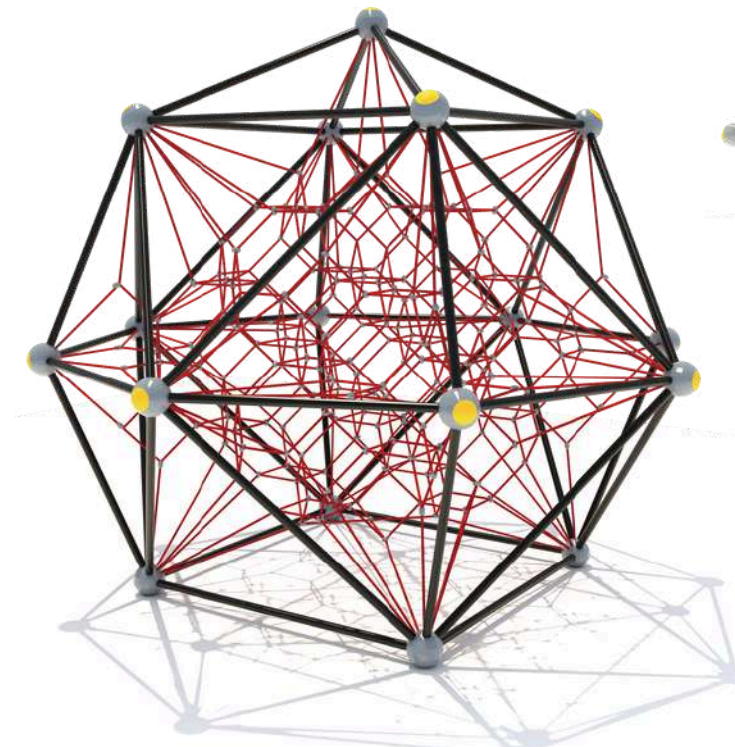

NC-18701

UNIT SIZE: 510*510*440 CM
SAFETY ZONE 870*870 CM



NC-18802

UNIT SIZE: 530*530*400 CM
SAFETY ZONE 890*890 CM

SEILSPIELANLAGEN

ROPE NET SYSTEMS | STRUCTURE DE CORDE À GRIMPER

Die vielfältigen Seilnetz-Spielgeräte inspirieren Kinder immer aufs Neue und bieten eine Menge an Herausforderungen.

The rope structures have a safe, durable, and ingeniously designed structure. Harmoniously coordinated, each part is skillfully combined, providing children with safety, vibrant colors, and long-lasting brightness.

les filets de corde offrent une structure sûre, durable et ingénieusement conçue. Harmonieusement coordonnée, chaque pièce est habilement combinée, offrant aux enfants sécurité, couleurs vives et brillance durable.

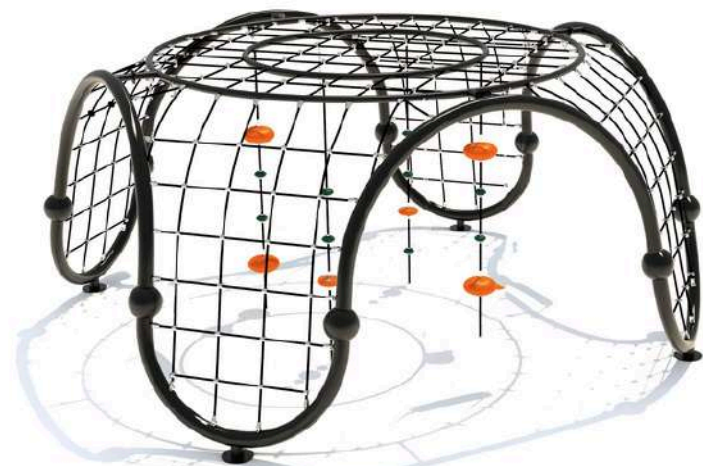

NC-18702

UNIT SIZE: 560*560*240 CM
SAFETY ZONE 920*920 CM





DREH- KARUSSELLS CAROUSELS



RP-20801
UNIT SIZE: 104*85*140 CM



RP-20702
UNIT SIZE: 200*190*200 CM

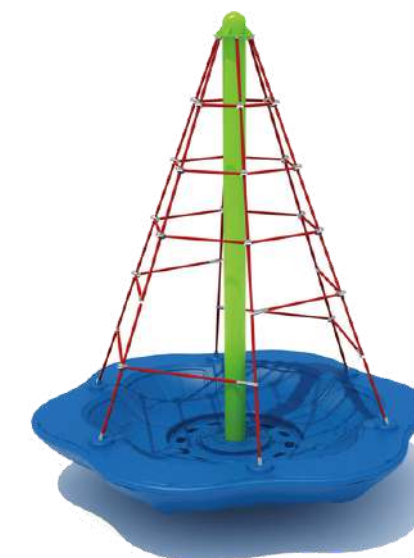

RP-20703
UNIT SIZE: 200*190*300 CM



RP-20803
UNIT SIZE: Ø200*66 CM



RP-20804
UNIT SIZE: Ø220*84 CM



RP-20701
UNIT SIZE: Ø198*76 CM



RP-20705
UNIT SIZE: Ø170*100 CM



RP-20805
UNIT SIZE: 188*188*92 CM



RP-20806
UNIT SIZE: 193*189*92 CM



RP-20706
UNIT SIZE: Ø170*126 CM



RP-20704
UNIT SIZE: Ø170*117 CM



WIPPEN

ROCKERS I GAMME À BASCULE



ES-20108

UNIT SIZE: 204*178*84 CM

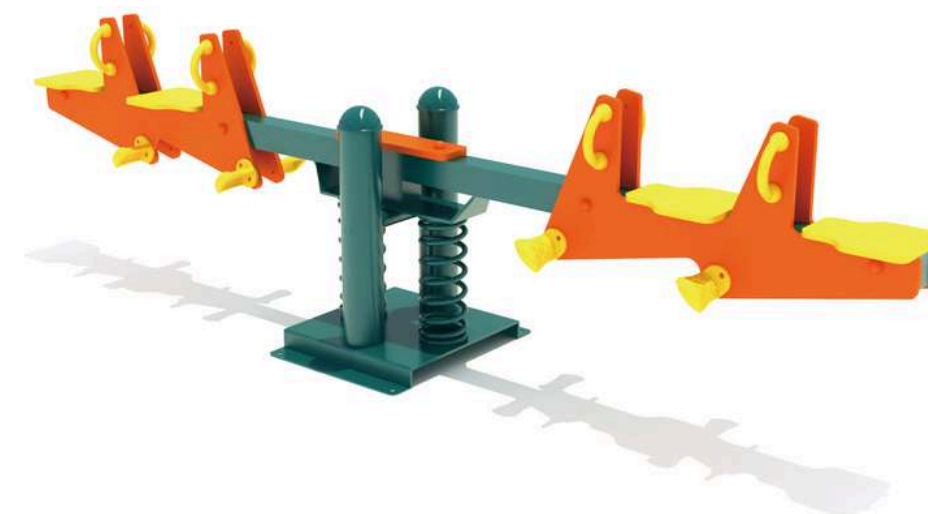

ES-20104

UNIT SIZE: 300*57*81 CM

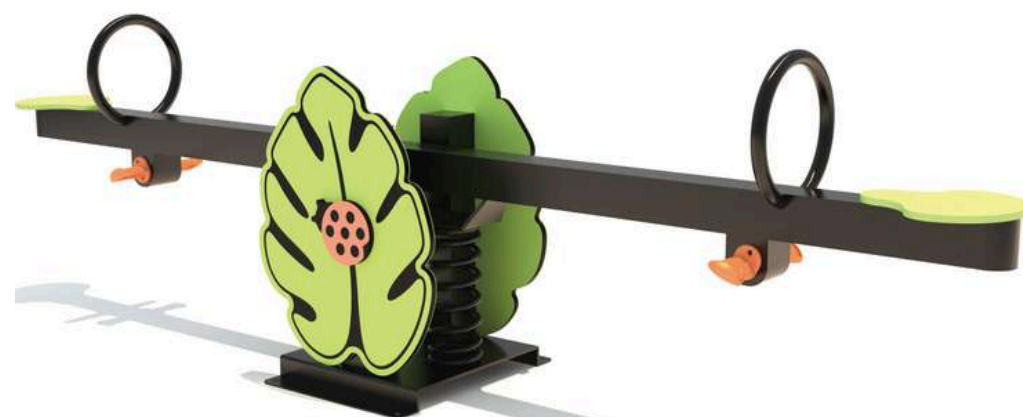

ES-20101

UNIT SIZE: 313*61*88 CM

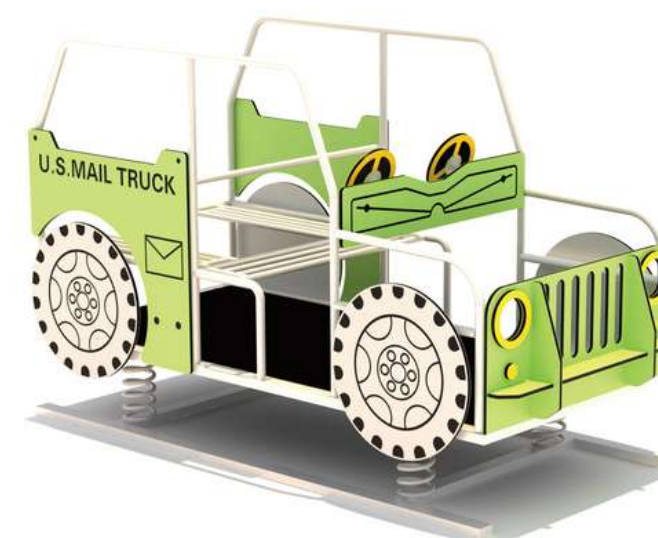

ES-20202

UNIT SIZE: 282*136*180 CM



ES-20103

UNIT SIZE: 263*58*140 CM

ES-20203

UNIT SIZE: 269*166*168 CM





S-20401
UNIT SIZE: 170*150*300 CM



S-20402
UNIT SIZE: 350*120*230 CM



SCHAUKELN

SWINGS I GAMME SWING

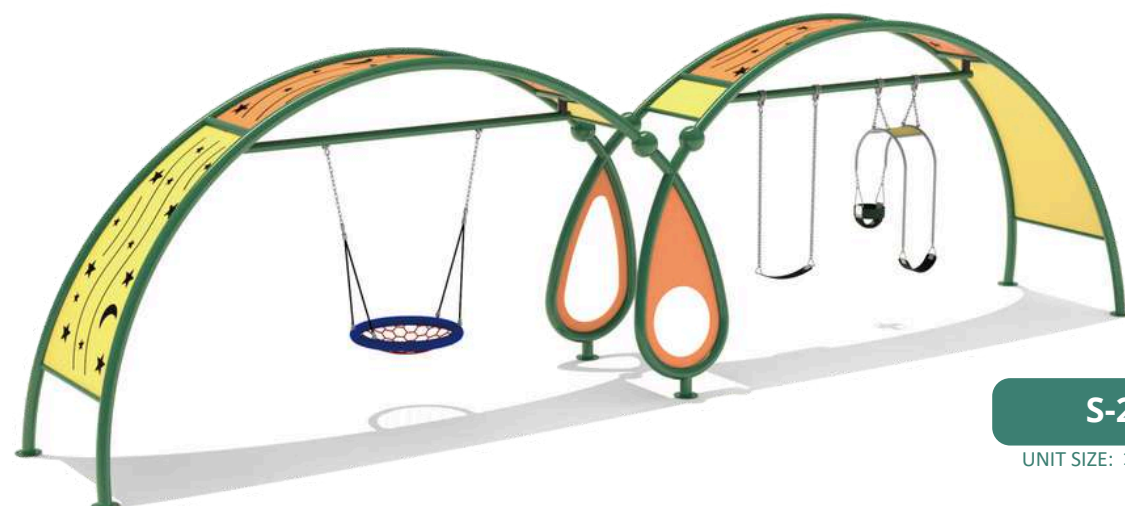

S-20301
UNIT SIZE: 1160*160*330 CM



S-20403
UNIT SIZE: 300*110*230 CM



S-20404
UNIT SIZE: 358*128*235 CM

S-20302
UNIT SIZE: 700*120*230 CM



S-20405
UNIT SIZE: 358*128*235 CM



S-20406
UNIT SIZE: 358*128*235 CM



MUSIKSPIEL SERIE

MUSIC PLAY SERIES | GAMME MUSICALE



MT-20903

UNIT SIZE: 180*16*160 CM



MT-20904

UNIT SIZE: 95*58*95 CM



MT-20905

UNIT SIZE: 70*63*95 CM



MT-21005

UNIT SIZE: 80*60*90 CM



MT-20902

UNIT SIZE: 100*98*100 CM



MT-20901

UNIT SIZE: 75*35*90 CM



MT-21004

UNIT SIZE: 140*53*80 CM



MT-21001

UNIT SIZE: Φ 20*60, Φ 25*65,
 Φ 30*70, Φ 35*75,
 Φ 40*80



SAND & WASSERSPIEL

SAND & WATERPLAY | GAMME EAU ET SABLE

Kinder lieben es zu experimentieren, beobachten, Sand und Wasser zu erforschen. Mit unserem Produktsortiment geben wir ihnen eine Vielzahl an Möglichkeiten dies auszuleben.

Children need physical and mental challenges while they play . We offer them the chance to thrive in a safe and fun environment.

Les enfants ont besoin de défis physiques et mentaux lorsqu'ils jouent. Nous leur offrons la chance de s'épanouir dans un environnement sûr et amusant.



PE-17502

UNIT SIZE: 380*380*220 CM
SAFETY ZONE 750*750 CM

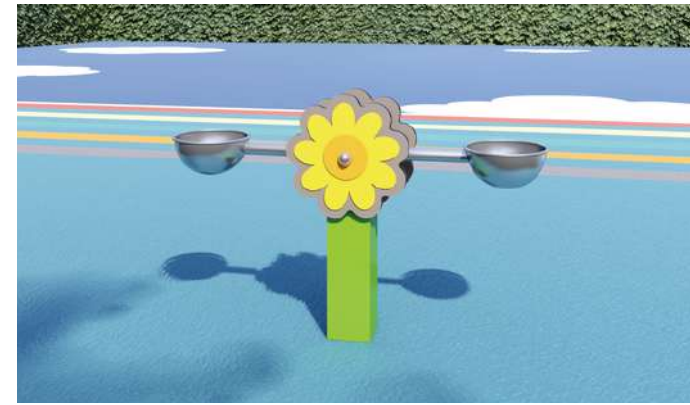

PE-17602

UNIT SIZE: 97*28*56 CM



PE-17604

UNIT SIZE: 132*36*78 CM



PE-17601

UNIT SIZE: 200*100*85 CM



PE-17603

UNIT SIZE: 126*37*110 CM

PE-17605

UNIT SIZE: 175*175*270 CM





PE-SR-19801
UNIT SIZE: 80*41*76 CM



PE-SR-19901
UNIT SIZE: 91*36*84 CM



PE-SR-19708
UNIT SIZE: 85*41*78 CM



PE-SR-19905
UNIT SIZE: 81*42*100 CM

KLEINSPIELGERÄTE

MINI-RIDER SERIES | GAMME MINI-RIDER

Die QualiTerra Wipptier-Serie bietet langlebige, farbenfrohe Federwippgeräte und kleine Spielanlagen. Perfekt für kleinere Gärten, Parks, Schulhöfe und Wohngebiete.

The QualiTerra Spring Riders series features durable, vibrant, and safe playground equipment designed to inspire imaginative play and promote physical activity. With a variety of engaging designs, these easy-to-install riders are perfect for parks, schoolyards, and residential areas.

La série QualiTerra Spring Riders comprend des équipements de jeux durables, dynamiques et sûrs conçus pour inspirer un jeu imaginaire et promouvoir l'activité physique. Avec une variété de designs attrayants, ces cavaliers faciles à installer sont parfaits pour les parcs, les cours d'école et les zones résidentielles.



PE-17404
UNIT SIZE: 200*190*210 CM



PE-17403
UNIT SIZE: 202*127*145 CM



PE-SR-19701
UNIT SIZE: 105*30*102 CM



PE-SR-19707
UNIT SIZE: 71*41*80 CM



PE-180201
UNIT SIZE: 370*280*200 CM
SAFETY ZONE 580*670 CM

